

# Rancho Santa Fe Fire Protection District Ordinance

# 2020-01



Adopted: November 20, 2019  
Effective: January 1, 2020

# Contents

Section 1 .....1

Section 2 .....1

Section 3 .....1

    Sec. 101.5 Validity. ....1

    Sec. 102.13. Repeal Of Conflicting Ordinances, Resolutions Or Motions. ....1

    Sec. 104.8 Modifications. ....1

    Sec. 104.12. Cost Recovery. ....2

        Sec. 104.12 Cost Recovery .....2

        Sec. 104.12.1 Reimbursement Required .....2

    Sec. 105.3.9. Expense Recovery. ....2

        Sec. 105.3.9 Expense Recovery .....2

    Sec. 105.6.6.52. Christmas Tree Lots. ....2

    Sec. 105.6.20.1. Greenwaste Recycling, Mulching, Composting Operations And Storage.....2

    Sec. 105.8. New Materials, Processes Or Occupancies Which Require Permits.....2

    Sec. 109. Appeals. ....2

        Sec. 109.1 Regional Fire Appeals Board Established .....3

        Sec. 109.2 Limitations On Authority. ....3

        Sec. 109.3 Qualifications.....3

        Sec. 109.4 Appeals Procedures.....3

        Sec. 109.4.1 Appeals Of Determinations Regarding Building Permits.....3

        Sec. 109.4.2 Appeals Of Determinations Regarding Discretionary Permits .....3

        Sec. 109.4.3 Appeals Of Determinations For Matters Other Than Building Permits Or Discretionary Permits3

    Sec. 110.4 Violations, Penalties And Responsibility For Compliance.....4

    Sec. 112.4 Failure To Comply. ....4

    Sec. 202. Definitions.....5

    Sec. 304.1.4. Outdoor Carnivals And Fairs. ....8

        Section 304.1.4 Is Added To The California Fire Code To Read:.....8

    Sec. 305.6. Rockets, Model Aircraft And Similar Devices. ....8

    Sec. 307.5. Attendance Of Open Burning And Recreational Fires. ....8

    Sec. 321. Mid-Rise Buildings. ....8

        Sec. 321.1 General .....8

        Sec. 321.1.1 Automatic Sprinkler Systems And Standpipes .....9

        Sec. 321.1.2 Smoke Detection. ....9

        Sec. 321.1.3 Fire Alarm System .....9

        Sec. 321.1.4 Emergency Voice Alarm Signaling System .....9

        Sec. 321.1.5 Fire Command Center ..... 10

Sec. 321.1.6 Annunciation Identification..... 10

Sec. 321.1.7 Elevators ..... 10

Sec. 321.1.8 Fire Department Communication System..... 10

Sec. 321.1.9 Means Of Egress ..... 10

Sec. 321.1.9.1 Extent Of Enclosure ..... 10

Sec. 321.1.9.2 Pressurized Enclosures And Stairways ..... 10

Sec. 321.1.9.3 Vestibules ..... 10

Sec. 321.1.9.4 Pressure Differences ..... 11

Sec. 321.1.9.5 Locking Of Stairway Doors..... 11

Sec. 322. Storage Of Firewood..... 11

Sec. 322.1 General ..... 11

Sec. 501.3.1 Fire Apparatus Access Modifications..... 11

Sec. 503 Fire Apparatus Access Roads ..... 11

Sec. 503.1 General ..... 11

503.1.1 Buildings And Facilities ..... 12

Sec. 503.1.2 Additional Access ..... 12

Sec. 503.1.3 High-Piled Storage ..... 12

Sec. 503.2.1 Dimensions ..... 12

Sec. 503.2.1.1 Road Phasing Requirement For Single Family Dwellings On Existing Legal Parcels..... 13

Table 503.2.1.1 -Phasing Requirement..... 13

Fire Apparatus Access Roadway – Single Family Dwellings..... 13

Sec. 503.2.2 Authority To Increase Minimums..... 13

Sec. 503.2.3 Surface..... 13

Sec. 503.2.4 Roadway Radius ..... 14

Sec. 503.2.5 Dead Ends..... 14

Sec. 503.2.5.1 Dead-End Roads ..... 14

Sec. 503.2.6 Bridges And Elevated Surfaces..... 14

Sec. 503.2.6.1 Bridges With One Traffic Lane..... 14

Sec. 503.2.7 Grade..... 15

Sec. 503.2.8 Angles Of Approach And Departure..... 15

Sec. 503.2.9 Roadway Turnouts ..... 15

Sec. 503.3 Marking ..... 15

Sec. 503.3.1 Fire Lane Designation ..... 15

Sec. 503.4 Obstruction Of Fire Apparatus Access Roads..... 15

Sec. 503.4.1 Traffic Calming Devices ..... 15

Sec. 503.5 Required Gates Or Barricades ..... 15

Sec. 503.5.1 Secured Gates And Barricades ..... 15

Sec. 503.5.2 School Fences And Gates ..... 16

Sec. 503.6 Security Gates..... 16

Sec. 505. Premises Identification. .... 16

505.1 Address Identification..... 17

Sec. 505.2 Street Or Road Signs..... 17

Sec 505.2.1 Traffic Access Limitations ..... 17

Sec. 505.3 Easement Address Signs..... 17

Sec. 505.4 Directory Map ..... 17

Sec. 505.5 Response Map Updates..... 17

Sec. 506.1.3. Emergency Key Access..... 17

Sec. 507.2. Type Of Water Supply..... 17

Sec. 507.2 Type Of Water Supply ..... 17

Sec. 507.2.1 Private Fire Service Mains ..... 18

Sec. 507.2.2 Water Tanks ..... 18

Table 507.2.2 ..... 18

Residential Water Tank Requirements ..... 18

Sec. 507.3. Fire Flow. .... 19

Sec. 507.5.7. Fire Hydrant And Fire Valve Location..... 19

Sec. 507.5.7.1 Signing Of Water Sources And Fire Department Connections..... 19

Sec. 507.5.8. Waterline Extensions. .... 19

Sec. 603.6.6. Spark Arresters. .... 19

Sec. 603.8.1. Residential Incinerators..... 19

Sec. 903.2 Automatic Sprinkler Systems-Where Required. .... 20

903.2(A) Additions ..... 20

903.2(B) Remodels Or Reconstructions..... 20

903.2(C) Group U Occupancies..... 20

Sec. 903.4. Automatic Sprinkler System Monitoring And Alarms..... 20

Sec. 1204.4 Ground-Mounted Photovoltaic Arrays..... 21

Sec. 1204.4 Ground-Mounted Photovoltaic Arrays..... 21

Sec. 1204.4.1 Fire Apparatus Access Roads..... 21

Sec. 1204.4.2 Perimeter Fire Apparatus Access Roadway..... 21

Sec. 1204.4.3 Fuel Modification ..... 21

Sec. 1204.4.4 Water Supply ..... 21

Sec. 1204.5 Identification ..... 21

Sec. 2808. Storage And Processing Of Wood Chips, Hogged Material, Fines, Compost, Solid Biomass Feedstock And Raw Product Associated With Yard Waste, Agro-Industrial And Recycling Facilities..... 21

Sec. 2808.1 General ..... 22

Sec. 2808.2 Definitions ..... 22

Sec. 2808.3 Permit Required ..... 22

Sec. 2808.4 Financial Assurance For Cost Recovery ..... 22

Sec. 2808.5 Operational And Emergency Plans ..... 22

Sec. 2808.6 Notification Of Fire Department ..... 22

Sec. 2808.7 Equipment Operator Emergency Callback ..... 22

Sec. 2808.8 Incoming Waste Diversion Plan ..... 22

Sec. 2808.9 Unprocessable Or Non-Greenwaste Material ..... 23

Sec. 2808.10 Fire Access Roadway ..... 23

Sec. 2808.11 Storage Sites ..... 23

Sec. 2808.12 Combustible Vegetation Control ..... 23

Sec. 2808.13 Pile Separation ..... 23

Sec. 2808.14 Size Of Piles ..... 23

Sec. 2808.15 Static Pile Protection ..... 23

Sec. 2808.16 Firefighting Water Supplies And Storage ..... 23

Sec. 2808.16.1 Public Water Supply ..... 23

Sec. 2808.16.2 Private Water Supply ..... 23

Sec. 2808.17 Material-Handling Equipment ..... 24

Sec. 2808.18 General Safety Rules For Site Equipment Maintenance ..... 24

Sec. 2808.19 Site Security ..... 24

Sec. 2808.20 Smoking And Open Burning Prohibited ..... 24

Sec. 3206.2. General Fire Protection And Life Safety Features. .... 24

Sec. 3318. Fuel Modification Zone Requirements ..... 24

Sec. 3318.1 Fuel Modification Zone During Construction ..... 24

Sec. 4902. Definitions ..... 24

Sec. 4902.1 General ..... 24

Sec. 4902.2 Declaration ..... 26

Sec. 4903. Fire Protection Plan. .... 26

Sec. 4903.1 When Required ..... 26

Sec. 4905. Wildfire Protection Building Construction ..... 26

Sec. 4905.1 Construction Methods For Exterior Wildfire Exposure ..... 26

Sec. 4907. Defensible Space ..... 26

Sec. 4907.1 Building And Structure Setbacks From Property Lines ..... 27

Sec. 4907.1.2 Fire Setbacks Adjacent Protected Areas ..... 27

Sec. 4907.1.3 Building And Structure Setback From Slope ..... 27

Sec. 4907.2 Fuel Modification ..... 27

Figure 4907.2 Measurements Of Fuel Modification Distance ..... 28

Sec. 4907.2.1 Fuel Modification Of Combustible Vegetation From Sides Of Roadways ..... 28

Sec. 4907.2.2 Community Fuel Modification..... 28

Sec. 4907.2.2.1 Land Ownership..... 29

Sec. 4907.3 Maintenance Of Defensible Space ..... 29

Sec. 4907.3.1 Trees ..... 29

Table 4907.3.1 ..... 29

Distance Between Tree Canopies ..... 29

Sec. 4907.3.3 Eucalyptus Forests And Oak Woodlands..... 29

Sec. 4907.4 Home Ignition Zones:..... 29

Sec. 4907.4.1 Zone 1 Immediate Zone 0-5' ..... 29

Sec. 4907.4.2 Zone 2 Intermediate Zone From Zone 5' To 50' ..... 30

Sec. 4907.4.3 Zone 3 Extended Zone 50'-100' ..... 30

Amendment To Section 4907.5..... 30

Sec. 4907.5 Landscape Plans ..... 30

Sec. 4907.5.1 Landscaping Requirements ..... 30

Sec. 4907.5.2 Landscaping Installation ..... 31

Sec. 5601.2. Explosives And Fireworks-Applicability. .... 31

Sec. 5601.2 Applicability ..... 31

Sec. 5601.2.1 Definitions ..... 31

Sec. 5601.2.2. Application ..... 31

Sec. 5601.2.3 Permit Requirements ..... 31

Sec. 5601.2.4 Permit Conditions..... 31

Sec. 5601.2.5 Insurance And Indemnification Required..... 32

Sec. 5601.2.6 Blasting Hours..... 32

Sec. 5601.2.7 Additional Operational Requirements ..... 32

Sec. 5601.2.8 Seizure Of Illegal Items..... 33

Sec. 5601.2.9 Violations For False Or Misleading Information..... 33

Sec. 5601.2.10 Fees ..... 33

Sec. 5608.1. Fireworks Display..... 33

Sec. 5608.1 General. .... 33

Sec. 5608.1.1 Scope ..... 33

Sec. 5705.2.4. Transferring Class I, Ii Or Iii Liquids..... 33

Sec. 5706.2.5.2.1 Tanks For Gravity Discharge. .... 34

Section 5706.2.5.2.1 Of The California Fire Code Is Added To Read: ..... 34

Sec. 5706.2.8.2 Prohibition On Use Of Tank Vehicle. .... 34

Sec. 6107.5. Safety Precautions And Devices-Securing Lpg Tanks..... 34

Sec. 8001. Referenced Standards..... 34

Sec. 8001. Referenced Standard Nfpa 13d ..... 34

5.1.1.2 Spare Sprinkler Heads ..... 34

7.1.5 Pressure-Reducing Valve ..... 34

7.2.5 Inspector Test ..... 34

7.3.4 Pressure Gauge ..... 35

7.6 Alarms ..... 35

10.2.5 Pressure Cushion ..... 35

11.2.1.1 Hydrostatic Tests ..... 36

12.3.6 Inactive Systems ..... 36

Sec. App.B103.3. Areas Without Water Supply Systems. .... 36

Sec. App.H100 Reporting Forms ..... 36

Section 4 ..... 36

    B.    Sec. 5706.2.4.4 ..... 36

    D.    Sec. 6104.2..... 37

Section 5 ..... 37

Section 6 ..... 37

Section 7 ..... 37

Section 8 ..... 38

Findings..... 39

    Additional Findings For Chapter 49..... 39

        Requirements For Wildland-Urban Interface Fire Areas ..... 39

    Definitions: ..... 39

        Climate ..... 39

        Topography..... 39

        Geography ..... 39

        Climatic Considerations ..... 39

        Topographic Considerations ..... 40

        Geographic Considerations..... 40

Findings For The Fire Code ..... 41

    Finding 1 ..... 41

    Finding 2 ..... 41

    Finding 3 ..... 41

    Finding 4 ..... 41

    Finding 5 ..... 42

    Finding 6 ..... 42

    Finding 7 ..... 42

    Finding 8 ..... 42

Attachment B..... 44  
..... 44  
Index By Code Section Consolidated Fire Code..... 45  
Index By Subject Consolidated Fire Code..... 51



## Ordinance No. 2020-01

### AN ORDINANCE OF THE RANCHO SANTA FE FIRE PROTECTION DISTRICT WHICH ADOPTS THE 2019 CALIFORNIA FIRE CODE AND THE 2018 INTERNATIONAL FIRE CODE WITH CERTAIN AMENDMENTS, ADDITIONS, AND DELETIONS

WHEREAS, Health & Safety Code section 17958 mandates that the Rancho Santa Fe Fire Protection District shall adopt Ordinances or regulations imposing the same requirements as are contained in the regulations adopted by the State pursuant to Health & Safety Code section 17922; and

WHEREAS, the State of California is mandated by Health & Safety Code section 17922 to impose the same requirements as are contained in the 2019 California Fire Code based on the 2018 International Fire Code published by the International Code Council, hereinafter referred to collectively as the Fire Code; and

WHEREAS, the State of California is mandated by Health & Safety Code section 17922 to impose the same requirements as are contained in the 2019 California Fire Code based on the 2018 International Fire Code, together with the Rancho Santa Fe Fire Protection District amendments, shall be the Rancho Santa Fe Fire Protection District Fire Code for the purpose of prescribing regulations in the unincorporated territory of the County of San Diego and the boundaries of the Rancho Santa Fe Fire Protection District; and

WHEREAS, code amendments adopted by the State of California shall take precedence over the 2018 International Fire Code language. The 2018 International Fire Code language shall be used for those code sections not adopted by the State; and

WHEREAS, local amendments adopted by the Rancho Santa Fe Fire Protection District shall take precedence over both the 2018 International Fire Code and 2019 California Fire Code provisions; and

WHEREAS, Health & Safety Code section 17958.5 permits the Rancho Santa Fe Fire Protection District to make such changes or modifications to the Codes as are reasonably necessary because of local conditions; and

WHEREAS, Health & Safety Code section 17958.7 requires that the Rancho Santa Fe Fire Protection District before making any changes or modifications pursuant to section 17958.5 make express findings that such changes or modifications are needed due to local climatic, geological, or topographical conditions; and

WHEREAS, the Board of Directors of the Rancho Santa Fe Fire Protection District does herewith find that the District has certain climatic, geological, and topographical features that can have a deleterious effect on emergency services such as fire protection and emergency medical services; and

WHEREAS, the Board of Directors of the Rancho Santa Fe Fire Protection District finds that the modifications and changes to the 2018 International Fire Code and 2019 California Fire Code are reasonably necessary because of the following local climatic, geological, and topographical conditions as identified in Attachment A; and

WHEREAS, certain amendments to the 2019 California Fire Code and the 2018 International Fire Code serve to mitigate to the extent possible said deleterious effects; and

WHEREAS, sections 50022.1 through 50022.10, inclusive, of the Government Code and section 13869 of the Health & Safety Code, provide authority for the adoption by reference of codes, or portion of such codes.

NOW, THEREFORE, the Board of Directors of the Rancho Santa Fe Fire Protection District does ordain as follows:

## **Section 1**

That Ordinance No. 2017-01, to the extent that the latter is or was effective, of the Rancho Santa Fe Fire Protection District and all other ordinance or parts of ordinances in conflict herewith are hereby repealed.

## **Section 2**

That the Board of Directors of the Rancho Santa Fe Fire Protection District adopts as the Fire Code for the Rancho Santa Fe Fire Protection District the following: the 2019 California Fire Code, including the appendices B, C, H, I & K the 2018 International Fire Code (IFC), and the National Fire Protection Association Standards 13, 13-R & 13-D as referenced in Chapter 80 of CFC, together with the District's amendments in this ordinance. This Fire Code is adopted for the protection of the public health and safety. It includes definitions, provisions for the safeguarding of life and property from fire and explosion hazards arising from the storage, handling and use of hazardous substances, materials and devices, and from conditions hazardous to life or property in the occupancy of buildings, requirements for permits and inspection for installing or altering systems, regulations for the erection, construction, enlargement, alteration, repair, moving, removal, conversion, demolition, equipment use and maintenance of buildings and structures, including the installation, alteration or repair of new and existing fire protection systems and their inspection and provides penalties for violation of this code. Each and all of the regulations, provisions, penalties, conditions and terms of the Rancho Santa Fe Fire Protection District Fire Code on file in the office of the Rancho Santa Fe Fire Protection District are hereby referred to, adopted, and made a part hereof, as if fully set out in this ordinance, with the additions, insertions, deletions and changes, if any, prescribed in Section 3 of this ordinance.

## **Section 3**

That the following sections and chapters of the 2019 California Fire Code are hereby revised:

### **SEC. 101.5 VALIDITY.**

Section 101.5 of the California Fire Code is revised to read:

**Sec. 101.5 Validity.** The Board of Supervisors declares that should any section, paragraph, sentence or word of this chapter be declared invalid for any reason it is the intent of this Board that it would have passed all other portions of this chapter independently of any portion that may be declared invalid.

### **SEC. 102.13. REPEAL OF CONFLICTING ORDINANCES, RESOLUTIONS OR MOTIONS.**

Section 102.13 is added to the California Fire Code to read:

**Sec. 102.13 Repeal of conflicting ordinances, resolutions or motions.** All former ordinances, resolutions or motions or parts thereof, conflicting or inconsistent with the provisions of this chapter are repealed.

### **SEC. 104.8 MODIFICATIONS.**

Section 104.8 of the California Fire Code is revised to read:

**Sec. 104.8 Modifications.** Whenever there are practical difficulties involved in carrying out the provisions of this code, the fire code official shall have the authority to grant modifications for individual cases, provided the fire code official shall first find that special individual reason makes the strict letter of this code impracticable and the modification is in compliance with the intent and purpose of this code and that such modification does not lessen health, life and fire safety requirements. The applicant's request for a modification shall state the specific sections(s) for which a modification is requested, material facts supporting the contention of the applicant, the details of the modification or mitigating measure proposed and, if applicable, a map showing the proposed location and citing of the modification or mitigation measure. The details of action

granting modifications shall be recorded and entered in the files of the department of fire prevention.

**SEC. 104.12. COST RECOVERY.**

Section 104.12 is added to the California Fire Code to read:

**Sec. 104.12 Cost Recovery.** The purpose of this section is to establish authority to obtain reimbursement from responsible individuals for the expenses of any emergency response and/or enforcement action by the fire department to protect the public from criminal or negligent activities, and from fire or hazardous substances.

**Sec. 104.12.1 Reimbursement Required.** In accordance with the Health and Safety Code section 13000 et seq., an individual who acts negligently or in violation of the law and thereby requires the jurisdiction to provide an emergency response to a danger posed by a fire or hazardous substance shall be liable for reimbursement to the agency for the costs incurred. In accordance with Government Code sections 53150 through 53158, any individual who is under the influence of an alcoholic beverage or any drug or the combined influence of an alcoholic beverage or any drug, and whose negligent operation of a motor vehicle, boat or vessel or civil aircraft caused by that influence proximately causes any incident and thereby requires the agency to provide an emergency response shall reimburse the agency for the cost incurred.

**SEC. 105.3.9. EXPENSE RECOVERY.**

Section 105.3.9 is added to the California Fire Code to read:

**Sec. 105.3.9 Expense Recovery.** The fire code official may impose a fee for recovery of expenses incurred to enforce the fire prevention provisions of this code.

**SEC. 105.6.6.52. CHRISTMAS TREE LOTS.**

Section 105.6.6.52 is added to the California Fire Code to read:

**Sec. 105.6.6.52 Christmas tree lots.** An operational permit is required to operate a Christmas tree lot, with or without flame proofing services.

**SEC. 105.6.20.1. GREENWASTE RECYCLING, MULCHING, COMPOSTING OPERATIONS AND STORAGE.**

Section 105.6.20.1 is added to the California Fire Code to read:

**Sec. 105.6.20.1 Greenwaste recycling, mulching, composting operations and storage.** An operational permit is required for greenwaste recycling, mulching, composting operations and storage.

**SEC. 105.8. NEW MATERIALS, PROCESSES OR OCCUPANCIES WHICH REQUIRE PERMITS.**

Section 105.8 is added to the California Fire Code to read:

**Sec. 105.8 New materials, processes or occupancies which require permits.** The fire code official may determine, after allowing affected persons an opportunity to be heard, that a material, process or occupancy, not listed in this code shall require a permit, in addition to those now enumerated in this code. In that case, the fire code official shall prepare a list of any additional material, process or occupancy that shall require a permit and post the list in a conspicuous place in the offices of the fire authority having jurisdiction. Any interested person may obtain a copy of the list.

**SEC. 109. APPEALS.**

Section 109 of the California Fire Code is revised to read:

**Sec. 109.1 Regional Fire Appeals Board established.** In order to hear and decide appeals of orders, decisions or determinations made by the fire code official relative to the application and interpretation of this code, including the granting or denial of modifications, there shall be and is hereby created a Regional Fire Appeals Board (Appeals Board). The Appeals Board shall adopt rules of procedure for conducting its business, and shall render all decisions and findings in writing to the appellant with a duplicate copy to the fire code official. A copy shall also be sent to the Building Official or other decision maker for the project, whichever is appropriate.

**Sec. 109.2 Limitations on authority.** An application for appeal shall be based on a claim that the intent of this code or the rules legally adopted hereunder have been incorrectly interpreted, the provisions of this code do not fully apply, or an equivalent method of protection or safety is proposed. The Appeals Board shall not have authority to waive requirements of this code.

**Sec. 109.3 Qualifications.** The Appeals Board shall consist of members who are qualified by experience and training to pass on matters pertaining to hazards of fire, explosions, hazardous conditions or fire protection systems and are not employees of the jurisdiction.

**Sec. 109.4 Appeals procedures.** This section establishes appeal procedures of an order, decision or determination (collectively, "determination") made by the fire code official, including the granting or denial of appeals.

**Sec. 109.4.1 Appeals of determinations regarding building permits.** The County, fire agency or project applicant may appeal a determination made by the fire code official related to a project for which a building permit is required by filing an appeal in writing with the Appeals Board within 30 days of the fire code official's final determination. The Appeals Board shall make factual findings and issue a written recommendation to the County Building Official on whether the fire code official's determination should be upheld, overruled or modified. The Building Official may not waive the requirements of this code, except as authorized by the code and is subject to the same requirements and restrictions in the code that applied to the fire code official. A copy of the recommendation shall be provided to the applicant. The County Building Official shall act on the Appeals Board's recommendation and issue a written decision to the parties within 15 days of receipt of the Appeals Board's recommendation. The Building Official's decision shall be final.

**Sec. 109.4.2 Appeals of determinations regarding discretionary permits.** The County, the fire agency or the project applicant may seek review of the fire code official's determination by the Appeals Board by filing a request for review with the Appeals Board within 30 days of the fire code official's determination. When reviewing a fire code official's determination pursuant to this subsection, the Appeals Board shall act in an advisory capacity. The Appeals Board shall review the fire code official's determination and make a recommendation to uphold, overrule or modify the fire code official's determination. The Appeals Board shall render its recommendation to the County decision maker or decision-making body for consideration with the application for the discretionary permit.

**Sec. 109.4.3 Appeals of determinations for matters other than building permits or discretionary permits.**

- a. **Areas outside a fire protection district.** Any affected party may appeal a determination made by the fire code official regarding a matter for which a building permit or discretionary permit is not required by filing an appeal in writing with the Appeals Board within 30 days of the fire code official's final determination. The Appeals Board shall

review the fire code official's determination and make a recommendation to uphold, overrule or modify the fire code official's determination. The Appeals Board's determination shall be final.

- b. **Areas inside a fire protection district.** Any affected party may appeal a determination made by the fire code official regarding a matter for which a building permit or discretionary permit is not required by filing an appeal in writing with the fire protection district's Board of Directors within 30 days of the fire code official's final determination. The Board of Directors shall review the fire code official's determination and make a recommendation to uphold, overrule or modify the fire code official's determination. The Board of Director's determination shall be final.

**Sec. 109.5 Regional Fire Appeals Board.**

- a. The Appeals Board members shall consist of the following:
  - Two representatives from the San Diego County Fire Districts Association.
  - Two chief officers from CAL FIRE.
  - One fire marshal from the unincorporated area of the County.
- b. The Appeals Board shall not include a representative from the agency whose fire code official made the determination that is being appealed. An alternate for the regular member(s) of the Appeals Board shall be designated to serve in this situation.
- c. Three members shall constitute a quorum for the transaction of business, and three affirmative votes shall be necessary to render a recommendation.
- d. If the Appeals Board recommends a modification to this code for an individual case, a copy of the recommendation and findings along with a map showing the proposed modification and mitigating measures shall be forwarded to the Unit Chief of CAL FIRE, San Diego/Imperial Unit.

**SEC. 110.4 VIOLATIONS, PENALTIES AND RESPONSIBILITY FOR COMPLIANCE.**

Section 110.4 of the California Fire Code is revised to read:

**Sec. 110.4 Violations, penalties and responsibility for compliance.** Any person who shall violate any of the provisions of this code or standards hereby adopted or fail to comply therewith, or who shall violate or fail to comply with any order made there under, or who shall build in violation of any detailed statement or specification or plans submitted and approved there under, or any certificate or permit issued there under, and from which no appeal has been taken, or who shall fail to comply with such an order as affirmed or modified by the attorney for the Rancho Santa Fe Fire Protection District or by a court of competent jurisdiction within the time fixed herein, shall severally for each and every violation and non-compliance respectively, be guilty of an infraction or misdemeanor, punishable by a fine not exceeding \$1,000.00 or by imprisonment in County Jail not exceeding six (6) months, or both. The imposition of one penalty of any violation shall not excuse the violation or permit it to continue; and all such persons shall be required to correct or remedy such violations or defects within a reasonable time; and when not otherwise specified, each day that prohibited conditions are maintained shall constitute a separate offense. The application of the above penalty shall not be held to prevent the enforced removal of prohibited conditions.

**SEC. 112.4 FAILURE TO COMPLY.**

Section 112.4 of the California Fire Code is revised to read:

**Sec. 112.4 Failure to comply.** Any person who shall continue any work, having been served with a stop work order, except such work as that the person is directed to perform to remove a

violation or unsafe condition, shall be liable to a fine of not less than \$250.00 or more than \$1,000.00.

**SEC. 202. DEFINITIONS.**

Section 202 of the California Fire Code is revised by adding or modifying the following definitions:

**ACCESSORY DWELLING UNIT.** Defined as an attached or a detached residential dwelling unit which provides complete independent living facilities for one or more persons. It shall include permanent provisions for living, sleeping, eating, cooking, and sanitation on the same parcel as the single-family dwelling is situated. An accessory dwelling unit also includes the following:

- a. An efficiency unit, as defined in Section 17958.1 of the Health and Safety Code.
- b. A manufactured home, as defined in Section 18007 of the Health and Safety Code.

**AERATED STATIC PILE.** A composting process that uses an air distribution system to blow or draw air through the pile. Little or no pile agitation or turning is performed.

**BLASTER.** A person who has been approved by the Sheriff to conduct blasting operations and who has been placed on the list of approved blasters. The listing shall be valid for one year unless revoked by the Sheriff.

**BLASTING AGENT.** A material or mixture consisting of a fuel and oxidizer intended for blasting. The finished product as mixed and packaged for use or shipment shall not be detonated by means of a No. 8 test blasting cap when unconfined.

**BLASTING OPERATION.** The uses of an explosive device or explosive material to destroy, modify, obliterate or remove any obstruction of any kind.

**BLASTING PERMIT.** A permit issued by the Issuing Officer pursuant to section 105.6.15. The permit shall apply to a specific site and shall be valid for a period not to exceed one year.

**BLAST SITE.** The geographically defined area, as shown on a project map or plot plan, where a blaster is authorized by a blasting permit issued under this section to conduct a blasting operation.

**CHIPPING AND GRINDING.** An activity that mechanically reduces the size of organic matter.

**COMPOSTING OPERATION.** An operation that is conducted for the purpose of producing compost. The operation shall be by one or more of the following processes used to produce a compost product, static pile, windrow pile or aerated static pile.

**DEAD-END ROAD.** A road that has only one point of vehicular ingress/egress, including cul-de-sacs and looped roads.

**DISTANCE MEASUREMENT.** All specified or referenced distances are measured along the ground, unless otherwise stated.

**DWELLING UNIT.** Any building or portion thereof which contains living facilities, including provisions for sleeping, eating, cooking and/or sanitation for not more than one family.

**ENCLOSED.** Closed in or fenced off.

**EXPLOSIVES PERMIT.** A permit to possess or use explosives, issued by the Issuing Officer, pursuant to California Health and Safety Code sections 12000 et seq. and Chapter 56 of this code. An explosives permit shall be valid for a period not to exceed one year, as provided in the permit conditions.

**FIRE APPARATUS ACCESS ROAD.** A road that provides fire apparatus access from a fire station to a facility, building or portion thereof. This is a general term that includes, but is not limited to a fire lane, public street, private street, driveway, and parking lot lane and access roadway.

**FIRE AUTHORITY HAVING JURISDICTION (FAHJ).** The designated entity providing enforcement of fire regulations as they relate to planning, construction and development. The FAHJ may also provide fire suppression and other emergency services.

**FIRE CHIEF.** The fire chief is one of the following:

- a. The person appointed by the Board of Supervisors to serve as fire chief in the unincorporated areas not within a fire protection district.
- b. The chief officer of a fire protection district.
- c. The Fire Warden or her or his delegated representative when enforcing section 5608.1 of this Chapter.

**FIRE CODE OFFICIAL.** The Fire Warden or her or his delegated representative, the fire chief or a duly authorized representative, or other person as may be designated by law, appointment or delegation and charged with the administration and enforcement of this Chapter.

**FIRE DEPARTMENT.** Any regularly organized fire department, fire protection district, fire company, or legally formed volunteer fire department registered with the County of San Diego regularly charged with the responsibility of providing fire protection to a jurisdiction.

**FIRE HAZARD.** Any condition or conduct which: (a) increases or may increase the threat of fire to a greater degree than customarily recognized as normal by persons in the public service regularly engaged in preventing, suppressing or extinguishing fire or (b) may obstruct, delay, hinder or interfere with the operations of the fire department or the egress of occupants in the event of fire.

**FIRE PROTECTION DISTRICT.** Any fire protection district created under State law and any water district providing fire protection services.

**FUEL MODIFICATION ZONE.** A strip of land where combustible vegetation has been thinned or modified or both and partially or totally replaced with approved fire-resistant and/or irrigated plants to provide an acceptable level of risk from vegetation fires. Fuel modification reduces the radiant and convective heat on a structure and provides valuable defensible space for firefighters to make an effective stand against an approaching fire front.

**GREENWASTE.** Organic material that includes, but is not limited to, yard trimmings, plant waste, manure, untreated wood wastes, paper products and natural fiber products.

**HARDSCAPE.** Concrete, gravel, pavers or other non-combustible material.

**HAZARDOUS FIRE AREA.** Any geographic area mapped by the State or designated by a local jurisdiction as a moderate, high or very high fire hazard area or which the FAHJ has determined is a hazardous fire area, because the type and condition of vegetation, topography, weather and structure density increase the probability that the area will be susceptible to a wildfire.

**HOGGED MATERIALS.** Mill waste consisting mainly of hogged bark but may include a mixture of bark, chips, dust or other by-product from trees and vegetation.

**INSPECTOR.** For the purposes of sections 5601.2, an inspector is a person on the Issuing Officer’s approved list of inspectors authorized to conduct inspections, before and after a blast. To be on the Issuing Officer’s approved list, an inspector shall have a blasting license issued by Cal/OSHA.

**MAJOR BLASTING.** A blasting operation that does not meet the criteria for minor blasting.

**MID-RISE BUILDING.** A building four stories or more high, but not exceeding 75 feet in height and not defined as a high-rise building by section 202 of the California Building Code. Measurements shall be made from the underside of the roof or floor above the topmost space that may be occupied to the lowest fire apparatus access road level.

**MINOR BLASTING.** A blasting operation that meets all of the following criteria: quantity of rock to be blasted does not exceed 100 cubic yards per shot, bore hole diameter does not exceed 2 inches, hole depth does not exceed 12 feet, maximum charge weight does not exceed 8 pounds of explosives per delay and the initiation of each charge will be separated by at least 8 milliseconds. The maximum charge weight shall not exceed the Scaled Distance as shown below:

Distance from Blast Site (In Feet)	Scale-Distance Factor
0 - 300.....	Mandatory Seismic Monitoring
301 - 5,000.....	.55
5,000+.....	.65

**MULCHING.** The process by which mixed greenwaste is mechanically reduced in size for the purpose of making compost.

**RESPONSE TIME.** The elapsed time from the fire department’s receipt of the first alarm to when the first fire unit arrives at the scene.

**SKY LANTERN.** An unmanned device with a fuel source that incorporates an open flame in order to make the device airborne.

**STATIC PILE.** A composting process that is similar to the aerated static pile except that the air source may or may not be controlled.

**STRUCTURE.** That which is built or constructed, an edifice or building of any kind, or any piece of work artificially built up or composed of parts joined together in some manner.

**TRAVEL TIME.** The estimated time it would take for a responding agency to travel from the fire station to the furthest structure in a proposed development project, determined by measuring



the safest, most direct, appropriate and reliable route with consideration given to safe operating speeds for heavy fire apparatus.

**WINDROW COMPOSTING PROCESS.** The process in which compostable material is placed in elongated piles. The piles or windrows are aerated and/or mechanically turned on a periodic basis.

**WOOD CHIPS.** Chips of various species of wood produced or used in chipping and grinding operations.

**SEC. 304.1.4. OUTDOOR CARNIVALS AND FAIRS.**

Section 304.1.4 is added to the California Fire Code to read:

**Sec. 304.1.4 Outdoor carnivals and fairs.** Outdoor carnivals and fairs shall only be conducted on grounds free of combustible vegetation or trimmed to the satisfaction of the FAHJ.

**SEC. 305.6. ROCKETS, MODEL AIRCRAFT AND SIMILAR DEVICES.**

Section 305.6 is added to the California Fire Code to read:

**Sec. 305.6 Rockets, model aircraft and similar devices.** Rockets, model airplanes, gliders, balloons, sky lanterns, floating luminary or similar devices powered with an engine, propellant, open flame or other feature liable to start or cause a fire shall not be projected into or across hazardous fire areas without prior approval of the fire code official.

**SEC. 307.5. ATTENDANCE OF OPEN BURNING AND RECREATIONAL FIRES.**

Section 307.5 of the California Fire Code is revised to read:

**Sec. 307.5 Attendance.** Open burning, bonfires, recreational fires and the use of portable outdoor fireplaces shall be constantly attended by an adult until the fire is extinguished. Not fewer than one portable fire extinguisher complying with section 906 with a minimum 4-A rating or other approved on-site fire-extinguishing equipment, such as dirt, sand, water barrel, garden hose or water truck, shall be available for immediate utilization. All “warming fires”, by which open burning of wood, shall have installed a “spark arrester” of ½” screen or smaller installed or used in accordance with the manufacturer’s instructions.

**SEC. 321. MID-RISE BUILDINGS.**

Section 321 is added to the California Fire Code to read:

**SECTION 321  
MID-RISE BUILDINGS**

**Sec. 321.1 General.** A newly constructed mid-rise building or a mid-rise building which undergoes a complete renovation that requires the building to be completely vacated shall comply with this section.

**Exceptions:**

1. Buildings used exclusively as an open parking garage.
2. Buildings where all floors above the fourth floor level are used exclusively as an open parking garage.
3. Buildings such as a power plant, lookout tower, steeple, grain house, and other similar structures with intermittent human occupancy.

**Sec. 321.1.1 Automatic sprinkler systems and standpipes.** Mid-rise buildings shall be protected throughout by an automatic sprinkler system designed and installed in conformance with the NFPA 13 as referenced in Chapter 80 of CFC and in accordance with the following:

1. A control valve and a water flow alarm shall be provided for each floor. Each control valve and water flow alarm shall be electronically supervised.
2. Mid-rise buildings shall be provided with a Class I standpipe system that is interconnected with the automatic sprinkler system. The system shall consist of 2½-inch hose valves located in each stair enclosure on every floor. Two hose outlets shall be located on the roof outside of each stair enclosure which penetrates the roof. The standpipe system shall be designed, installed and tested in accordance with the NFPA 14 as referenced in Chapter 80 of CFC.
3. Fire department standpipe connections and valves serving each floor shall be located in the vestibule and located in a manner so as not to obstruct egress when hose lines are connected and charged.

**Sec. 321.1.2 Smoke detection.** Smoke detectors shall be provided in accordance with this section. Smoke detectors shall be connected to an automatic fire alarm system and shall be installed in accordance with the NFPA 72 as referenced in Chapter 80 of CFC. The actuation of any device required by this section shall operate the emergency voice alarm signal system and shall operate all equipment necessary to prevent the circulation of smoke through air return and exhaust ductwork. Smoke detectors shall be located as follows:

1. In every mechanical equipment, electrical, transformer, telephone equipment, unmanned computer equipment, elevator machinery or similar room and in all elevator lobbies. Elevator lobby detectors shall be connected to an alarm verification zone or be listed as a releasing device.
2. In the main return air and exhaust air plenum of each air conditioning system. The smoke detector shall be located in a serviceable area downstream of the last duct inlet.
3. At each connection to a vertical duct or riser serving two or more stories from a return air duct or plenum of an air conditioning system. In Group R-1 and R-2 occupancies, an approved smoke detector is allowed to be used in each return air riser carrying not more than 5,000 cubic feet per minute and not serving more than 10 air inlet openings.
4. For Group R-1 and R-2 occupancies in all corridors serving as a means of egress for an occupant load of 10 or more persons.

**Sec. 321.1.3 Fire alarm system.** An approved and listed, automatic and manual, fully addressable and electronically-supervised fire alarm system shall be provided in conformance with this code and the California Building Code & NFPA 72 as referenced in Chapter 80 of CFC.

**Sec. 321.1.4 Emergency voice alarm signaling system.** The operation of any automatic fire detector or water flow device shall automatically sound an alert tone followed by a pre-recorded voice instruction giving appropriate information and direction on a general or selective basis to the following terminal areas:

1. Elevators
2. Elevator lobbies
3. Corridors
4. Exit stairways
5. Rooms and tenant spaces
6. Dwelling units
7. Hotel guest rooms
8. Areas designated as safe refuge within the building

**Sec. 321.1.5 Fire command center.** A fire command center for fire department operations shall be provided. The location and accessibility of the fire command center shall be approved by the fire code official. The room shall be separated from the remainder of the building by not less than a 1 hour fire barrier. The room shall be a minimum of 200 square feet with a minimum dimension of 10 feet. It shall contain the following facilities at a minimum:

1. Voice alarm and public address panels
2. Fire department communications panel
3. Fire alarm annunciator panel
4. Elevator annunciator panel (when building exceeds 55 feet in height)
5. Status indicators and controls for air-handling systems (stairwell pressurization)
6. Controls for unlocking stairwell doors
7. Fire pump status indicators (if required)
8. Set of complete building plans
9. Elevator control switches for switching of emergency power
10. Work table

**Sec. 321.1.6 Annunciation identification.** Control panels in the central control station shall be permanently identified as to their function. Water flow, automatic fire detection and manually-activated fire alarms, supervisory and trouble signals shall be monitored by an approved UL-listed central monitoring station and annunciated in the fire command center by means of an audible and visual indicator. For the purposes of annunciation, zoning shall be in accordance with the following:

1. When the system serves more than one building, each building shall be a separate zone.
2. Each floor in a building shall be a separate zone.
3. When one or more risers serve the same floor, each riser shall be a separate zone.

**Sec. 321.1.7 Elevators.** Elevators and elevator lobbies shall comply with Chapter 30 of the California Building Code. At least one elevator cab shall be assigned for fire department use, and shall serve all floors of the building. This cab shall be provided large enough to accommodate an ambulance-type stretcher in accordance with section 3002.4 of the California Building Code.

**Sec. 321.1.8 Fire department communication system.** An approved two-way fire department communication system designed and installed in accordance with the NFPA 72 as referenced in Chapter 80 of CFC shall be provided for fire department use per section 907.2.13.2.

**Sec. 321.1.9 Means of egress.** In addition to the requirements of Chapter 10, egress components of mid-rise buildings shall comply with sections 321.1.9.1 through 321.1.9.5.

**Sec. 321.1.9.1 Extent of enclosure.** Stairway enclosures shall be continuous and shall fully enclose all portions of the stairway. Exit enclosures shall exit directly to the exterior of the building or include an exit passageway on the ground floor leading to the exterior of the building. Each exit enclosure shall extend completely through the roof and be provided with a door that leads onto the roof.

**Sec. 321.1.9.2 Pressurized enclosures and stairways.** All required stairways and enclosures in a mid-rise building shall be pressurized as specified in section 909. Pressurized stairways shall be designed to exhaust smoke manually when needed.

**Sec. 321.1.9.3 Vestibules.** Pressurized stairway enclosures serving a mid-rise building shall be provided with a pressurized entrance vestibule on each floor that complies with section 909.

**Sec. 321.1.9.4 Pressure differences.** The minimum pressure difference between a vestibule and adjacent areas shall comply with section 909.

**Sec. 321.1.9.5 Locking of stairway doors.** All stairway doors that are locked to prohibit access from the interior of the stairway shall have the capability of being unlocked simultaneously, without unlatching, upon a signal from the fire command center. Upon failure of normal electrical service or activation of any fire alarm, the locking mechanism shall automatically retract to the unlocked position.

A telephone or other two-way communication system connected to an approved emergency service which operates continuously shall be provided at not less than every third floor in each required exit stairway vestibule.

Approved signage stating doors are locked shall be provided in each stairwell vestibule on each floor in which entry may be made and on each floor in which a telephone is located. Hardware for locking stairway vestibule doors shall be State Fire Marshal listed and approved by the fire code official by permit before installation. Stairway doors located between the vestibules and the stairway shaft shall not be locked.

**SEC. 322. STORAGE OF FIREWOOD.**

Section 322 is added to the California Fire Code to read:

**SECTION 322  
STORAGE OF FIREWOOD**

**Sec. 322.1 General.** Firewood shall not be stored in unenclosed space beneath a building or structure, on a deck or under eaves, a canopy or other projection or overhang. When required by the fire code official, firewood or other combustible material stored in the defensible space surrounding a structure shall be located at least 30 feet from any structure and separated by a minimum of 15 feet from the drip line of any trees, measured horizontally. Firewood and combustible materials not for use on the premises shall be stored so as to not pose a fire hazard. Wood storage shall be located on bare soil or a non-combustible material. Minimum clearance around wood storage pile shall be 10' bare soil, free of vegetation or other combustible material measured on a horizontal plane.

The maximum size of wood storage shall be 2 cords of woods with the pile dimensions no greater than 4 feet in height, 4 feet in width, and 16 feet in length.

**Exception:** Permit may be issued by the FAHJ for wood storage amounts in excess of this section.

**SEC. 501.3.1 FIRE APPARATUS ACCESS MODIFICATIONS**

Section 501.3.1 is added to the California Fire Code to read:

**Sec. 501.3.1 Fire apparatus access modifications.** Plans for the modification of fire apparatus access road shall be submitted to the fire code official for review and approval prior to construction or modification of any fire apparatus road.

**SEC. 503 FIRE APPARATUS ACCESS ROADS**

Section 503 of the California Fire Code is revised to read:

**SECTION 503  
FIRE APPARATUS ACCESS ROADS**

**Sec. 503.1 General.** Fire apparatus access roads shall be provided and maintained in accordance with Sections 503.1.1 through 503.1.3.

Fire apparatus access roads shall be provided and maintained in compliance with this section and the most recent edition and any amendments thereto, of public and private road standards as adopted by the County of San Diego (San Diego County Standards for Private Roads and Public Roads, San Diego County Department of Public Works). The fire code official may modify the requirements of this section if the modification provides equivalent access.

**503.1.1 Buildings and facilities.**

Approved fire apparatus access roads shall be provided for every facility, building or portion of a building hereafter constructed or moved into or within the jurisdiction. The fire apparatus access road shall comply with the requirements of this section and shall extend to within 150 feet (45 720 mm) of all portions of the facility and all portions of the exterior walls of the first story of the building as measured by an approved route around the exterior of the building or facility.

**Exceptions:**

1. The fire code official is authorized to increase the dimension of 150 feet (45 720 mm) where any of the following conditions occur:
  - 1.1. The building is equipped throughout with an approved automatic sprinkler system installed in accordance with Section 903.3.1.1, 903.3.1.2 or 903.3.1.3.
  - 1.2. Fire apparatus access roads cannot be installed because of location on property, topography, waterways, non-negotiable grades or other similar conditions, and an approved alternative means of fire protection is provided.
  - 1.3. There are not more than two Group R-3 or Group U occupancies.
2. Where approved by the fire code official, fire apparatus access roads shall be permitted to be exempted or modified for solar photovoltaic power generation facilities.

**Sec. 503.1.2 Additional access.** The fire code official is authorized to require Discretionary projects located in State Responsibility Areas (SRA) & Local Responsibility Areas (LRA) with Very High Fire Hazard Severity Zones (VHFHSZ) more than one fire apparatus access road based on the potential for impairment of a single road by vehicle congestion, condition of terrain, climatic conditions or other factors that could limit access. When additional fire apparatus access roads are necessary as mitigation for the exceedance of the maximum allowable dead-end road length, the additional fire apparatus access road must be remote from the primary fire apparatus access road.

**Sec. 503.1.3 High-piled storage.** Fire department vehicle access to buildings used for high-piled combustible storage shall comply with the applicable provisions of Chapter 32.

**503.2 Specifications.** Fire apparatus access roads shall be installed and arranged in accordance with Sections 503.2.1 through 503.2.9.

**Sec. 503.2.1 Dimensions.** The dimensions of fire apparatus access roads shall be in accordance with the following:

- a. Fire apparatus access roads shall have an unobstructed improved width of not less than 24 feet, except for single-family residential driveways serving no more than two residential parcels, which shall have a minimum of 16 feet of unobstructed improved width. Any of the following, which have separated lanes of one-way traffic: gated entrances with card readers, guard stations or center medians, are allowed, provided that each lane is not less than 14 feet wide.
- b. Fire apparatus access roads that are public or private roads which are provided or improved as a result of a Tentative Map, Tentative Parcel Map or a Major/Minor Use Permit shall have the dimensions as set forth by the County of San Diego Standards for Public and Private Roads.

- c. All fire apparatus access roads shall have an unobstructed vertical clearance of not less than 13 feet 6 inches.
- d. Vertical clearances or road widths shall be increased when the fire code official determines that vertical clearances or road widths are not adequate to provide fire apparatus access.
- e. Vertical clearances or road width may be reduced when the fire code official determines the reduction does not impair access by fire apparatus. In cases where the vertical clearance has been reduced, approved signs shall be installed and maintained indicating the amount of vertical clearance.
- f. Driveways exceeding 150 feet in length, but less than 600 feet in length, shall provide a turnout near the midpoint of the driveway. Where the driveway exceeds 600 feet, turnouts shall be provided no more than 400 feet apart.

**Sec. 503.2.1.1 Road phasing requirement for single family dwellings on existing legal parcels.**

- a. The fire access roadway requirement for widening an existing, improved and paved fire apparatus roadway shall be as provided in Table 503.2.1.1. The fire access roadway shall be constructed to extend from the property line to the nearest public road.

**TABLE 503.2.1.1 -PHASING REQUIREMENT  
Fire Apparatus Access Roadway – Single Family Dwellings**

Number of Parcels Served	Unobstructed Road Width	Roadways Over 600 foot Long
1-2	16-foot, paved	Turnouts every 400 feet
3-8	20-foot, paved	Turnouts every 400 feet
9 or more	24-foot, paved	Not required

- b. The access roadway shall not be required to be improved for a non-habitable accessory structure or a residential addition or remodel less than 500 square feet if the access roadway has already been improved and paved to a minimum width of 20 feet. If the roadway is less than 20 feet wide, the roadway shall be widened to 20 feet. The preceding addition or remodel exception is limited to one permit per three-year period from the date of the last permit approval.

**Exception:** Vertical clearances or road width may be reduced when the fire code official determines the reduction does not impair access by fire apparatus. In cases where the vertical clearance has been reduced, approved signs shall be installed and maintained indicating the amount of vertical clearance.

**Sec. 503.2.2 Authority to increase minimums.** The fire code official shall have the authority to require or permit modifications to the required access widths where they are inadequate for fire or rescue operations or where necessary to meet the public safety objectives of the jurisdiction.

**Sec. 503.2.3 Surface.** Fire apparatus access roads shall be designed and maintained to support the imposed loads of fire apparatus (not less than 75,000 lbs. unless authorized by the FAHJ) and shall be provided with an approved paved surface so as to provide all-weather driving capabilities. The paving and sub-base shall be installed to the standards specified in the County of San Diego Parking Design Manual. A residential driveway constructed of 3½" Portland cement concrete may be installed on any slope up to

20% provided that slopes over 15% have a deep broom finish perpendicular to the direction of travel or other approved surface to enhance traction.

**Sec. 503.2.4 Roadway radius.** The horizontal inside radius of a fire apparatus access road shall comply with the County of San Diego Public and Private Road Standards approved by the Board of Supervisors. The horizontal inside radius for a private residential driveway shall be a minimum of 28 feet, as measured on the inside edge of the improvement width or as approved by the fire code official. The length of vertical curves of fire apparatus access roads shall not be less than 100 feet, or as approved by the fire code official.

**Sec. 503.2.5 Dead ends.** Dead-end fire apparatus access roads in excess of 150 feet in length shall be provided with an approved area for turning around emergency apparatus. A cul-de-sac or other approved turn-around shall be provided in residential areas where the access roadway serves more than 2 structures. The minimum unobstructed radius width for a cul-de-sac in a residential area shall be 36 feet paved, 40 feet graded, or as approved by the fire code official. The fire code official shall establish a policy identifying acceptable turnarounds for various project types. See annex section of this code for illustrations.

**Sec. 503.2.5.1 Dead-end roads.** The maximum length of a dead-end road, including all dead-end roads accessed from that dead-end road, shall not exceed the following cumulative lengths, regardless of the number of parcels served:

(Title 14 SRA 1273.09 Ref.)

<u>ZONING FOR PARCEL SERVED BY DEAD-END ROAD(S)</u>	<u>CUMULATIVE LENGTH OF DEAD-END ROAD(S)</u>
Parcels zoned for less than 1 acre	800 feet
Parcels zoned for 1 acre to 4.99 acres	1,320 feet
Parcels zoned for 5 acres to 19.99 acres	2,640 feet
Parcels zoned for 20 acres or larger	5,280 feet

All lengths shall be measured from the edge of the roadway surface at the intersection where the road begins to the end of the road surface at its farthest point. Where a dead-end road crosses areas of differing zoned parcel sizes, requiring different length limits, the shortest allowable length shall apply. Where parcels are zoned 5 acres or larger, turnarounds shall be provided at a maximum of 1,320 foot intervals. Each dead-end road shall have a turnaround approved by the fire code official and constructed at its terminus.

A turnaround shall be provided to all building sites on driveways over 150 feet in length, and shall be within fifty (50) feet of the building.

**Sec. 503.2.6 Bridges and elevated surfaces.** Where a bridge or an elevated surface is part of a fire apparatus access road, the bridge shall be constructed and maintained in accordance with AASHTO HB-17. Bridges and elevated surfaces shall be designed for a live load sufficient to carry the imposed loads of fire apparatus. Vehicle load limits and clearance limitations shall be posted at both entrances to bridges where required by the fire code official. Where elevated surfaces designed for emergency vehicle use are adjacent to surfaces which are not designed for such use, approved barriers, approved signs or both shall be installed and maintained where required by the fire code official.

**Sec. 503.2.6.1 Bridges with one traffic lane.** When approved by the fire code official, private bridges providing access to not more than two residential dwellings may have one 12 foot wide travel lane and it

shall provide for unobstructed visibility from one end to the other, and turnouts shall be provided at both ends.

**Sec. 503.2.7 Grade.** The gradient for a fire apparatus access roadway shall not exceed 15.0%. The fire code official may allow roadway grades up to 20.0% provided that the roadway surface conforms to section 503.2.3. The fire code official may require additional mitigation measures.

**Sec. 503.2.7.1 Cross-Slope.** The standard cross-slope shall be 2 percent; minimum cross-slope shall be 1 percent; maximum cross-slope shall be 5 percent.

**Sec. 503.2.8 Angles of Approach and Departure.** The angles of approach and departure for fire apparatus access roads shall not exceed 7 degrees (12 percent) for the first 30' or as approved by the fire code official and shall not allow for transitions between grades that exceed 6% elevation change along any 10 foot section

**Sec. 503.2.9 Roadway Turnouts.** When required by the fire code official, turnouts shall be a minimum of 12 feet wide and 30 feet long with a minimum 25 foot taper on each end. (Title 14 SRA 1273.06)

**Exception:** The minimum width of the turnout may be reduced to 10 feet wide when the fire code official determines the reduction does not impair access by fire apparatus.

**Sec. 503.3 Marking.** When required by the fire code official, approved signs or other approved notices or markings that include the words "NO PARKING FIRE LANE" shall be provided for fire apparatus access roads to identify such roads or prohibit the obstruction thereof. Signs or notices shall be maintained in a clean and legible condition at all times and be replaced or repaired when necessary to provide adequate visibility. All new public roads, all private roads within major subdivisions and all private road easements serving four or more parcels shall be named. Road name signs shall comply with County of San Diego Department of Public Works Design Standard #DS-13.

**Sec. 503.3.1 Fire lane Designation.** Where the fire code official determines that it is necessary to ensure adequate fire access, the fire code official may designate existing roadways as fire access roadways as provided by Vehicle Code section 22500.1.

**Sec. 503.4 Obstruction of fire apparatus access roads.** Fire apparatus access roads shall not be obstructed in any manner, including the parking of vehicles. The minimum road widths and clearances established in sections 503.2.1 and 503.2.2 shall be maintained at all times.

**Sec. 503.4.1 Traffic calming devices.** Traffic calming devices (including, but not limited to, speed bumps, speed humps, speed control dips, etc.) shall be prohibited unless approved by the fire code official.

**Sec. 503.5 Required gates or barricades.** The fire code official is authorized to require the installation and maintenance of gates or other approved barricades across fire apparatus access roads, trails or other access ways, not including public streets, alleys or highways. Electric gate openers, where provided, shall be listed in accordance with UL 325. Gates intended for automatic operation shall be designed, constructed and installed to comply with the requirements of ASTM F2200.

**Sec. 503.5.1 Secured gates and barricades.** When required, gates and barricades shall be secured as approved by the fire code official. Roads, trails and other access ways that have been closed and obstructed in the manner prescribed by section 503.5 shall not be trespassed on or used unless authorized by the owner and the fire code official.



**Exception:** The restriction on use shall not apply to public officers acting within the scope of duty.

**Sec. 503.5.2 School fences and gates.** School grounds may be fenced and gates therein may be equipped with locks, provided that safe dispersal areas based on three square feet per occupant are located between the school and the fence. Such required safe dispersal areas shall not be located less than 50 feet from school buildings.

Every public and private school shall conform to Education Code section 32020, which states:

“The governing board of every public school district and the governing authority of every private school, which maintains any building used for the instruction or housing of school pupils on land entirely enclosed (except for building walls) by fences or walls, shall, through the cooperation of local law enforcement and fire protection agencies having jurisdiction of the area, provide for the erection of gates in these fences or walls. The gates shall be of sufficient size to permit the entrance of ambulances, police equipment and fire-fighting apparatus used by law enforcement and fire protection agencies. There shall be no less than one access gate and there shall be as many of these gates as needed to ensure access to all major buildings and ground areas. If these gates are equipped with locks, the locking devices shall be designed to permit ready entrance by the use of chain or bolt-cutting devices.”

**Sec. 503.6 Security gates.** No person shall install a security gate or security device across a fire access roadway without the fire code official's approval. If approved a security gate or security device across a fire access roadway shall include:

- a. An automatic gate across a fire access roadway or driveway shall be equipped with an approved emergency key-operated switch overriding all command functions and opening the gate.
- b. A gate accessing more than four residences or residential lots or a gate accessing hazardous, institutional, and educational or assembly occupancy group structure, shall also be equipped with an approved emergency traffic control-activating strobe light sensor or other device approved by the fire code official, which will activate the gate on the approach of emergency apparatus.
- c. An automatic gate shall be provided with a battery back-up or manual mechanical disconnect in case of power failure.
- d. An automatic gate shall meet fire department policies deemed necessary by the fire code official for rapid, reliable access.
- e. When required by the fire code official, an automatic gate in existence at the time of adoption of this chapter is required to install an approved emergency key-operated switch or other mechanism approved by the fire code official, at an approved location, which overrides all command functions and opens the gate. A property owner shall comply with this requirement within 90 days of receiving written notice to comply.
- f. Where this section requires an approved key-operated switch, it may be dual-keyed or equipped with dual switches provided to facilitate access by law enforcement personnel.
- g. All gates providing access from a road to a driveway shall be located a minimum of 30 feet from the nearest edge of the roadway and shall be at least two feet wider than the width of the traffic lane(s) serving the gate.

Electric gate openers, where provided, shall be listed in accordance with UL 325. Gates intended for automatic operation shall be designed, constructed and installed to comply with the requirements of ASTM F2200.

**SEC. 505. PREMISES IDENTIFICATION.**

Section 505 of the California Fire Code is revised to read:

**SECTION 505  
PREMISES IDENTIFICATION**

**505.1 Address identification.** New and existing buildings shall be provided with approved address identification. The address identification shall be legible and placed in a position that is visible from the street or road fronting the property. Address identification characters shall contrast with their background. Address numbers shall be Arabic numbers or alphabetical letters. Numbers shall not be spelled out. Each character shall be not less than 4 inches (102 mm) high with a minimum stroke width of 1/2 inch (12.7 mm) for residential buildings, 8" high with a 1" stroke for commercial and multi-family residential buildings and 12" high with a 1" stroke for industrial buildings. Where required by the fire code official, address identification shall be provided in additional approved locations to facilitate emergency response. Where access is by means of a private road and the building cannot be viewed from the public way, a monument, pole or other sign or means shall be used to identify the structure. Address identification shall be maintained.

**Sec. 505.2 Street or road signs.** Streets and roads shall be identified with approved signs. Temporary signs shall be installed at each street intersection when construction of new roadways allows passage by vehicles. Signs shall be of an approved size, weather-resistant and be maintained until replaced by permanent signs.

**Sec 505.2.1 Traffic Access Limitations.** Signs identifying traffic access limitations shall be placed at the intersection preceding the traffic access limitation, and no more than 100 feet before such traffic access limitation

**Sec. 505.3 Easement address signs.** A road easement which is not named differently from the roadway from which it originates shall have an address sign installed and maintained listing all street numbers occurring on that easement. The sign shall be located where the easement intersects the named roadway. The numbers on the sign shall contrast with the background and have a minimum height of 4" and a minimum stroke of 1/2".

**Sec. 505.4 Directory map.** A lighted directory map, meeting current fire department standards, shall be installed at the driveway entrance to a residential project or a mobile home park, with more than 15 units.

**Sec. 505.5 Response map updates.** Any new development which necessitates updating emergency response maps due to new structures, hydrants, roadways or similar features shall be required to provide map updates in a format compatible with current department mapping services and shall be charged a reasonable fee for updating all response maps.

**SEC. 506.1.3. EMERGENCY KEY ACCESS.**

Section 506.1.3 is added to the California Fire Code portion to read:

**Sec. 506.1.3 Emergency key access.** All central station-monitored fire detection systems and automatic sprinkler systems shall have an approved emergency key access box on site in an approved location. The owner or occupant shall provide and maintain current keys for any structure for fire department placement in the box and shall notify the fire department in writing when the building is re-keyed.

**SEC. 507.2. TYPE OF WATER SUPPLY.**

Section 507.2 of the California Fire Code is revised to read:

**Sec. 507.2 Type of water supply.** A water supply may consist of reservoirs, pressure tanks, elevated tanks, water mains or other fixed systems, as approved by the fire code official, capable of providing the required fire flow. In setting the requirements for fire flow, the fire code official shall follow section 507.3 or

Appendix B of the CFC, or the standard published by the Insurance Services Office, "Guide for Determination of Required Fire Flow".

**Sec. 507.2.1 Private fire service mains.** Private fire service mains and appurtenances shall be installed in accordance with NFPA 24 as referenced in Chapter 80 of CFC.

**Sec. 507.2.2 Water tanks.** Water tanks for private residential fire protection, when authorized by the fire code official, shall comply with Table 507.2.2 and be installed in accordance with the NFPA 22 edition referenced in Chapter 80 of CFC. Water tanks for commercial fire protection, when authorized by the fire code official, shall be installed in accordance with the NFPA 22 edition referenced in Chapter 80 of CFC.

<b>TABLE 507.2.2 RESIDENTIAL WATER TANK REQUIREMENTS</b>			
Building Square Feet	Gallons Per Minute Water Flow	Capacity Gallons	Duration Minutes
Up to 1,500	250	5,000	20
Over 1,500	250	10,000	40
When the exposure distance is one hundred feet (100') or less from an adjacent property, or where additional hazards or higher fire flow exists, the required water storage may be modified by the fire code official.			

1. Tank bottom elevation shall be equal to or higher than the fire department connection on the premises. Regardless of domestic use, all tanks shall be equipped with a device that will ensure that the tank contains the designated amount of water for fire flow duration as determined by the FAHJ. Tank size may be increased to serve multiple structures on a single parcel. The bottom of the water storage tank shall be level with or above the building pad.
2. Supply outlet shall be at least one-4 inch in diameter from the base of the tank to the point of outlet at the fire department connection. The fire department connection shall have an approved means of controlling water flow. The fire department connection shall be at least one-4 inch National Standard Thread (male), reduced to one- 2½ inch National Standard Thread (male). Additional outlets may be required.
3. Location of fire department outlet shall be shown on the plot plan when submitted to the FAHJ. Consideration will be given to topography, elevations, and distance from structures, driveway access, prevailing winds, etc.
4. The outlet shall be located along a fire apparatus access roadway and shall not be closer than 50 feet or further than 150 feet from the structure unless approved by the FAHJ.
5. All exposed tank supply pipes shall be listed for above-ground use as per the NFPA 13 edition referenced in Chapter 80 of CFC. Adequate support shall be provided.
6. Water storage tanks shall be constructed from materials approved by the NFPA 22 edition referenced in Chapter 80 of CFC and installed per manufacturer instructions.
7. Plans shall be submitted to the FAHJ for approval prior to tank installation. Tanks shall be installed as per County Zoning setback requirements.
8. Vessels previously used for products other than water shall not be allowed.
9. All underground piping serving the fire department connection shall be listed and approved as per the NFPA 24 edition referenced in Chapter 80 of CFC.

**SEC. 507.3. FIRE FLOW.**

Section 507.3 of the California Fire Code is revised to read:

**Sec. 507.3 Fire flow.** Fire flow requirements shall be based on Appendix B of the California Fire Code or the standard published by the Insurance Services Office, "Guide for Determination of Required Fire Flow." Consideration should be given to increasing the gallons per minute to protect buildings and structures of extremely large square footage and for such reasons as: poor access roads, grade and canyon rims, hazardous brush and response times greater than five minutes by a recognized fire department or fire suppression company. In hazardous fire areas the main capacity for new subdivisions shall not be less than 2,500 gallons per minute, unless otherwise approved by the fire code official. If fire flow increases are not feasible, the fire code official may require alternative design standards such as: alternative types of construction that provides a higher level of fire resistance, fuel break requirements, which may include required irrigation, modified access road requirements, specified setback distances for building sites addressing canyon rim developments and hazardous brush areas, and other requirements as authorized by this chapter and as required by the fire code official.

**SEC. 507.5.7. FIRE HYDRANT AND FIRE VALVE LOCATION.**

Section 507.5.7 is added to the California Fire Code to read: (Title 14 1275.15)

**Sec. 507.5.7 Fire hydrant and fire valve location.** The fire hydrant or fire valve shall be between 14 to 24 inches above grade, no closer than 4 feet nor further than 12 feet from the roadway, and 8 feet from combustible vegetation.

**Sec. 507.5.7.1 Signing of water sources and fire department connections.** The fire code official shall require fire hydrants and fire department connections to be identified. Fire hydrants shall be identified by a reflectorized blue marker and fire department connections shall be identified by a reflectorized green marker, with a minimum dimension of 3 inches, in the center of the travel lane adjacent the water source, or by other methods approved by the fire code official.

All materials shall be listed and approved by the water purveyor and/or fire code official. The fire code official may require a fire hydrant to have any combination of one-4 inch and one-2 ½ inch outlets with National Standard Threads.

**SEC. 507.5.8. WATERLINE EXTENSIONS.**

Section 507.5.8 is added to the California Fire Code to read:

**Sec. 507.5.8 Waterline Extensions.** The fire code official may require a waterline extension for the purpose of installing a fire hydrant if a water main is 1,500 feet or less from the property line.

**SEC. 603.6.6. SPARK ARRESTERS.**

Section 603.6.6 is added to the California Fire Code to read:

**Sec. 603.6.6 Spark arresters.** All buildings and structures having a chimney, flue or stovepipe attached to a fireplace, stove, barbecue or other solid or liquid fuel burning equipment or device shall have the chimney, flue or stovepipe equipped with an approved spark arrester. An approved spark arrester is a device intended to prevent sparks from escaping into the atmosphere, constructed of welded or woven wire mesh, 12-gauge thickness or larger, with openings no greater than ½" inch, or other alternative material the FAHJ determines provides equal or better protection.

**SEC. 603.8.1. RESIDENTIAL INCINERATORS.**

Section 603.8.1 of the California Fire Code is revised to read:

**Sec. 603.8.1 Residential Incinerators.** Residential incinerators are prohibited in the unincorporated area of the County.

**SEC. 903.2 AUTOMATIC SPRINKLER SYSTEMS-WHERE REQUIRED.**

Section 903.2 of the California Fire Code is revised to read:

**903.2 Where required.** Approved automatic sprinkler systems shall be installed in all new buildings. For the purpose of automatic sprinkler systems, buildings separated by less than 10 feet from adjacent buildings shall be considered one building. Fire barriers and partitions, regardless of rating, shall not be considered as creating separate buildings for purposes of determining automatic sprinkler system requirements. Mezzanines shall be included in the total square footage calculation. All new buildings constructed shall have an approved NFPA 13, NFPA 13R or NFPA 13D automatic sprinkler system installed as per 903.3.1.1, 903.3.1.2 or 903.3.1.3. The Fire Code Official has the final decision of which NFPA 13 standard to apply, NFPA 13R or NFPA 13D as required due to access, water supply and travel time.

**Exceptions:**

1. Group U occupancies not greater than 500 square feet, when the building is 20 feet or more from an adjacent building and 30 feet from property line measured from the farthest projection from the building.
2. Agricultural buildings constructed of wood or metal frames over which fabric or similar material is stretched, which are specifically used as green houses are exempt from the automatic sprinkler system requirements unless physically connected to other building.

**903.2(a) Additions.** An automatic sprinkler system may be required to be installed throughout the building when the addition is more than 50% of the existing building or when the altered building will exceed a fire flow as calculated pursuant to section 507.3. The fire code official may require an automatic sprinkler system to be installed in buildings where no water main exists to provide the required fire flow or where a special hazard exists, such as poor access roads, steep grades and canyon rims, hazardous brush and response times greater than 5 minutes by a fire department. The fire code official may require that other protective measures be taken based on existing conditions and/or potential hazards. The preceding addition or remodel exception is limited to one permit per three-year period from the date of the last permit approval.

**903.2(b) Remodels or reconstructions.** The fire code official may require an automatic sprinkler system to be installed throughout buildings if a remodel or reconstruction includes significant modification to the interior or roof of the building. The fire code official may require that other protective measures be taken based on existing conditions and/or potential hazards. The preceding addition or remodel exception is limited to one permit per three-year period from the date of the last permit approval.

**903.2(c) Group U Occupancies.** For Group U Occupancies greater than 500 square feet, an approved automatic sprinkler system shall be installed as per NFPA 13D edition referenced in Chapter 80 CFC or as approved by the FAHJ.

**SEC. 903.4. AUTOMATIC SPRINKLER SYSTEM MONITORING AND ALARMS.**

Section 903.4 of the California Fire Code is revised to read:

**Sec. 903.4 Automatic Sprinkler system supervision and alarms.** All valves controlling the water supply for automatic sprinkler systems, pumps, tanks, water levels and temperatures, critical air pressures and water-flow switches on all automatic sprinkler systems shall be electronically supervised by a listed fire alarm control unit.

**Exceptions:**

1. Automatic sprinkler systems with less than 100 fire sprinklers protecting one-family and two-family dwellings and group U occupancies.
2. Limited area sprinkler systems in accordance with Section 903.3.8.
3. Automatic sprinkler systems installed in accordance with NFPA 13R edition referenced in Chapter 80 CFC where a common supply main is used to supply both domestic water and the

automatic sprinkler system and a separate control valve for the automatic sprinkler system is not provided.

4. Jockey pump control valves that are sealed or locked in the open position.
5. Control valves to commercial kitchen hoods, paint spray booths or dip tanks that are sealed or locked in the open position.
6. Valves controlling the fuel supply to fire pump engines that are sealed or locked in the open position.
7. Trim valves to pressure switches in dry, preaction and deluge sprinkler systems that are sealed or locked in the open position.

**SEC. 1204.4 GROUND-MOUNTED PHOTOVOLTAIC ARRAYS.**

Section 1204.4 of the California Fire Code is revised to read:

**Sec. 1204.4 Ground-mounted photovoltaic arrays.** Ground-mounted photovoltaic array installations shall meet the requirements of sections 1204.4.1 through 1204.4.4.

**Sec. 1204.4.1 Fire apparatus access roads.** Fire apparatus access roads to ground-mounted photovoltaic arrays, associated equipment structures and operations/maintenance buildings shall comply with section 503.

**Exception:** Private residential and agricultural systems less than 10 acres in size and where the energy generated is primarily for on-site use are exempt from this requirement subject to the approval of the fire code official.

**Sec. 1204.4.2 Perimeter fire apparatus access roadway.** Ground-mounted photovoltaic arrays 10 acres or larger in size shall provide a fire apparatus access roadway around the perimeter of the project. The perimeter fire apparatus access roadway shall comply with section 503.

**Sec. 1204.4.3 Fuel modification.** Combustible vegetation within the array and to a distance of 30 feet from the array and associated equipment shall be reduced to a height of no more than 6 inches. The fuel modification zone may be increased when required by the fire code official or as recommend by a fire protection plan.

**Exception:** For private residential and agricultural systems less than 10 acres in size and where the energy generated is used primarily on-site, the required fuel modification zone may be reduced to 10 feet from the array and associated equipment.

Operation/maintenance buildings shall be provided with fuel modification zones that comply with section 4907.2.

**Sec. 1204.4.4 Water supply.** Water supply for fire protection and suppression shall be provided for equipment structures and operations/maintenance buildings as required by section 507.

**Sec. 1204.5 Identification.** Ground-mounted photovoltaic arrays with multiple equipment structures shall include a means of readily identifying each equipment structure. The fire code official may require a lighted directory map of the project to be installed on-site near the entrance to the facility for projects of 10 or more acres in size.

**SEC. 2808. STORAGE AND PROCESSING OF WOOD CHIPS, HOGGED MATERIAL, FINES, COMPOST, SOLID BIOMASS FEEDSTOCK AND RAW PRODUCT ASSOCIATED WITH YARD WASTE, AGRO-INDUSTRIAL AND RECYCLING FACILITIES.**

Section 2808 of the California Fire Code is revised to read:

**SECTION 2808**

**STORAGE AND PROCESSING OF WOOD CHIPS, HOGGED MATERIALS, FINES, COMPOST, SOLID BIOMASS FEEDSTOCK AND RAW PRODUCT ASSOCIATED WITH YARD WASTE, AGRO-INDUSTRIAL AND RECYCLING FACILITIES**

**Sec. 2808.1 General.** The storage and processing (mulching, composting) of wood chips, hogged materials, fines, compost, solid biomass feedstock and raw product produced from yard waste, debris and agro-industrial and recycling facilities shall be in accordance with section 2808.

**Sec. 2808.2 Definitions.** The following terms are defined in section 202:

AERATED STATIC PILE.

CHIPPING AND GRINDING.

COMPOSTING OPERATION.

GREENWASTE.

HOGGED MATERIALS.

MULCHING.

STATIC PILE.

WINDROW COMPOSTING PROCESS.

WOOD CHIPS.

**Sec. 2808.3 Permit required.** A permit shall be obtained from the fire code official prior to engaging in the operation and storing process of wood chips, hogged material, fines, compost and raw product in association with yard waste and similar material recycling facilities. The permit shall be renewed on an annual basis or shall be limited to such period of time as designated by the fire code official. Permits shall not be transferable and any change in use, location, occupancy, operation or ownership shall require a new permit.

**Sec. 2808.4 Financial assurance for cost recovery.** A security bond, irrevocable letter of credit or other approved form of financial assurance shall be required to be posted, in an amount determined by the fire code official. The financial assurance shall be a minimum of \$25,000.00 and a maximum of \$100,000.00, depending on the size of operation. The financial assurance shall reimburse the fire department for expenses incurred in any emergency response and/or enforcement action by the fire department to protect the public from fire or hazardous substances related to the operation. The financial assurance shall be returned to the operator in a timely fashion once the operation is closed, to the satisfaction of the fire code official.

**Sec. 2808.5 Operational and emergency plans.** The following operational and emergency action plans shall be submitted to and be approved by the fire code official prior to initiating an operation under section 2808:

1. Operational Plan. The operational plan shall include: Site layout, pile dimensions, fire access, water supply, site security, site operations, temperature monitoring, and rotation and diversion plan.
2. Emergency Plan. The emergency plan shall include: Operator fire response actions, fire dispersal area, emergency equipment operator callback and initiation of incoming diversion plan. All plans shall define the equipment necessary to process and handle the materials.

**Sec. 2808.6 Notification of fire department.** The operator shall report all fires to the fire department immediately upon discovery.

**Sec. 2808.7 Equipment operator emergency callback.** The operator shall implement and maintain a plan for rapid equipment operator response to the site. The maximum response time to the site shall be within one hour of a fire department notification. The following equipment shall be on site and staffed with skilled operators: bulldozer, loaders and heavy duty equipment necessary to mitigate a fire. Notification procedure shall be maintained operational 24 hours a day, seven days a week. Notification may be by pager activation, telephone answering service, or other approved means.

**Sec. 2808.8 Incoming waste diversion plan.** The operator shall develop a diversion plan for incoming greenwaste for implementation in the event of equipment failure or other inability to process and distribute greenwaste. The plan shall prevent stockpiling of waste on the site and unauthorized depositing

of waste on or near the site. The operator shall initiate the diversion plan based on criteria in the Operational and Emergency Plan without further direction from the fire department.

**Sec. 2808.9 Unprocessable or non-greenwaste material.** All greenwaste that cannot be processed on-site, such as stumps and fibrous plants, shall be immediately removed from the feedstock, stored in roll-off containers or bins and be removed from the facility on a weekly basis. All plastic bags shall be removed prior to shredding material.

**Sec. 2808.10 Fire access roadway.** A fire access roadway shall be provided to the site and on the site. Each roadway shall be at least 20 feet wide, but the fire code official may require a greater width, depending on site conditions. The operator shall also be required to obtain the fire code official's approval for the type of driving surface for the onsite access roadway.

**Sec. 2808.11 Storage sites.** Storage sites shall be level and on solid ground or other approved all-weather surface.

**Sec. 2808.12 Combustible vegetation control.** The operator shall clear any combustible material, weeds, brush, trees or other vegetation (including mulch) that is or may become, dry and capable of transmitting fire, from within 50 feet of raw greenwaste and mulch piles. Clearance shall be to bare earth or approved pavement. Individual growing trees within that distance may remain, subject to the fire code official's approval.

**Sec. 2808.13 Pile separation.** Piles shall be separated from adjacent piles and property lines by fire department access roadways.

**Sec. 2808.14 Size of piles.** Pile height, width and length shall be limited to criteria approved by the fire code official, based in part on the site material handling equipment. In no case shall a pile exceed 12 feet in height, 100 feet in width and 200 feet in length.

**Sec. 2808.15 Static pile protection.** Interior pile temperatures shall be monitored and recorded on a regular basis per the Operational Plan. Internal pile temperatures shall be taken at  $\frac{2}{3}$  the pile height, 12 to 24 inches from the surface with a probe-type thermometer. Readings shall be made at not greater than 50-foot intervals along the length of the pile. Temperatures above 158° F are known to adversely affect microbial decomposition and are considered excessive. Infrared thermometers may be used to monitor for hot spots at the surface, but are not a substitute for internal probe measurement and documentation. Once windrows exceed 170° F, the windrows shall be reduced in size, be rotated and be monitored daily until temperatures drop below 158° F. All greenwaste stockpiles shall be re-mixed as necessary to alleviate any fire due to spontaneous combustion or temperatures above 170° F. Windrows shall be visually inspected on a regular basis. Once fires have been detected in any windrows at a site, this visual inspection shall be a minimum daily requirement. Daily inspections shall continue until the threat of fire no longer exists and the fire code official agrees inspections may be discontinued. All temperature and pile-handling records shall be kept on file at the site and be made available for inspection by fire department personnel. Data shall include date, time, temperature, specific location and person conducting measurement.

**Sec. 2808.16 Firefighting water supplies and storage.** Firefighting water supplies shall conform to sections 2808.16.1 or 2808.16.2.

**Sec. 2808.16.1 Public water supply.** The operator shall provide and maintain approved fire hydrants and waterline mains as required by the fire code official. Water lines may be approved aboveground lines supplied from a reliable water supply with adequate protection against impact and fire flow reaction. Hydrant spacing shall be at 400-foot intervals along primary fire access roadways. Fire flow at each hydrant shall be least 1000 gallons per minute at 20 psi. Duration of the required fire flow shall be as determined by the fire code official.

**Sec. 2808.16.2 Private water supply.** Above-ground water storage tanks may be installed when authorized by the fire code official where public water supply is not adequate to meet fire flow requirements. Volume and duration of the required fire flow shall be as determined by the fire code official.



**Sec. 2808.17 Material-handling equipment.** Equipment used on all piles should be of a type that minimizes compaction. All vehicles operating on or around the piles shall have a Class A fire extinguisher of a minimum 2-A rating, in addition to the Class B rating appropriate for the vehicles. Approved material-handling equipment shall be available during firefighting operations for moving wood chips, hogged material, compost and raw product produced from yard waste and wood fines.

**Sec. 2808.18 General safety rules for site equipment maintenance.** Welding or cutting torch operations shall be conducted a minimum of 30 feet from combustible materials. A fire watch shall be provided to detect fire, and to operate fire-extinguishing equipment throughout the welding or cutting operation and 30 minutes thereafter. Refueling and on-site maintenance shall meet California Fire Code requirements in Chapters 23 & 57 and all other applicable fire code requirements.

**Sec. 2808.19 Site security.** Pile storage areas shall be surrounded with approved fencing. Fences shall be a minimum of 6 feet in height.

**Sec. 2808.20 Smoking and open burning prohibited.** The operator shall prohibit smoking and open flame on the operational site, including smoking within vehicles. Approved signs shall be clearly and prominently posted, and shall be enforced by the site operators. No open burning shall be allowed on site.

**SEC. 3206.2. GENERAL FIRE PROTECTION AND LIFE SAFETY FEATURES.**

Section 3206.2 Exception "H" of Table 3206.2 of the California Fire Code is deleted.

**SEC. 3318. FUEL MODIFICATION ZONE REQUIREMENTS**

Section 3318 is added to the California Fire Code to read:

**3318**

**FUEL MODIFICATION ZONE REQUIREMENTS**

**Sec. 3318.1 Fuel modification zone during construction.** Any person doing construction of any kind which requires a permit under this code or the County Building Code shall install a fuel modification zone prior to allowing any combustible material to arrive on the site and shall maintain the zone during the duration of the project.

**SEC. 4902. DEFINITIONS.**

Section 4902 of the California Fire Code is revised to read:

**SECTION 4902**

**DEFINITIONS**

**Sec. 4902.1 General.** For the purposes of this chapter, certain terms are defined as follows:

**BUILDING OFFICIAL** means the Director of the Planning and Development Services or any person appointed or hired by the Director to administer or enforce the County's planning and construction standards. The building official duties shall include plan checking, inspections and code enforcement.

**CDF DIRECTOR** means the Director of the California Department of Forestry and Fire Protection.

**COMBUSTIBLE VEGETATION** means material that in its natural state will readily ignite, burn and transmit fire from native or landscape plants to any building or other vegetation. Combustible vegetation includes dry grass, brush, weeds, litter or other flammable vegetation that creates a fire hazard.

**DEFENSIBLE SPACE** is an area either natural or man-made, where material capable of allowing a fire to spread unchecked has been treated, cleared or modified to slow the rate and intensity of an advancing

wildfire and to create an area for fire suppression operations to occur. Distance measurements for defensible space shall be measured on a horizontal plane.

**FIRE HAZARD SEVERITY ZONES** are geographical areas designated pursuant to California Public Resources Code sections 4201 through 4204 and classified as Very High, High and Moderate in State Responsibility Areas or as Local Agency Very High Fire Hazard Severity Zones designated pursuant to California Government Code sections 51175 through 51189.

The California Code of Regulations, Title 14, Section 1280 entitles maps of these geographical areas as "Maps of the Fire Hazard Severity Zones in the State Responsibility Area of California."

**FIRE PROTECTION PLAN (FPP)** is a document prepared for a specific project or development proposed in the wildland-urban interface fire area that describes ways to minimize and mitigate potential loss from wildfire exposure, with the purpose of reducing impact on the community's fire protection delivery system.

**FUEL BREAK** is an area, strategically located for fighting anticipated fires, where the native vegetation has been permanently modified or replaced so that fires burning into it can be more easily controlled. Fuel breaks divide fire-prone areas into smaller areas for easier fire control and to provide access for firefighting.

**LOCAL AGENCY VERY HIGH FIRE HAZARD SEVERITY ZONE** means an area designated by a local agency upon the recommendation of the CDF Director pursuant to Government Code sections 51177(c), 51178 and 51189 that is not a State Responsibility Area and where a local agency, city, county, city and county, or district is responsible for fire protection.

**OPEN SPACE EASEMENT** means any right or interest in perpetuity or for a term for years in open-space land, as that term is defined in Government Code section 51051, acquired by the County, a city or a non-profit organization where the instrument granting the right or interest imposes restriction on use of the land, to preserve the land for public use or enjoyment of the natural or scenic character of the land.

**OPEN SPACE PRESERVE** means open-space land, as that term is defined in Government Code section 65560(b), for the preservation of natural resources, managed production of resources, outdoor recreation, public health and safety, buffer for a military installation or the protection of cultural resources.

**SLOPE** is the variation of terrain from the horizontal; the number of feet, rise or fall per 100 feet, measured horizontally, expressed as a percentage.

**STATE RESPONSIBILITY AREA** means lands that are classified by the Board of Forestry pursuant to Public Resources Code section 4125 where the financial responsibility of preventing and suppressing forest fires is primarily the responsibility of the State.

**TREE CROWN** means the primary and secondary branches growing out from the main stem, together with twigs and foliage.

**WILDFIRE** is any uncontrolled fire spreading through vegetative fuels that threaten to destroy life, property, or resources as defined in Public Resources Code sections 4103 and 4104.

**WILDFIRE EXPOSURE** is one or a combination of radiant heat, convective heat, direct flame contact and burning embers being projected by vegetation fire to a building and structure and its immediate environment.

**WILDLAND-URBAN INTERFACE FIRE AREA** is a geographical area identified by the State as a "Fire Hazard Severity Zone" in accordance with the Public Resources Code sections 4201 through 4204 and Government Code sections 51175 through 51189, or other areas designated by the enforcing agency to be at a significant risk from wildfires.

**Sec. 4902.2 Declaration:** The legislative body shall declare the Wildland Interface Areas within the jurisdiction. The Wildland Urban Interface Areas shall be based on the findings of fact. The Wildland Urban Interface Area boundary shall be any geographic area mapped or otherwise identified by the State or local jurisdiction as a High Hazard, or Very High Fire Severity Zone, or as set forth by the Rancho Santa Fe Fire Protection District. When the type and condition of vegetation, topography, weather, and structure density, which potentially increases the probability of vegetation conflagration, exists, such area shall be considered a Very High Fire Hazard Severity Zone.

**SEC. 4903. FIRE PROTECTION PLAN.**

Section 4903 of the California Fire Code is revised to read:

**SECTION 4903  
FIRE PROTECTION PLAN**

**Sec. 4903.1 When required.** Planning and Development Services or the FAHJ may require an applicant for a parcel map, subdivision map, specific plan or major use permit for any property located in a wildland-urban interface fire area to submit a Fire Protection Plan (FPP) as part of the approval process.

**Sec. 4903.2 Content.** The FPP shall consider location, topography, geology, aspect, combustible vegetation (fuel types), climatic conditions and fire history. The plan shall address the following in terms of compliance with applicable codes and regulations including but not limited to: water supply, vehicular and emergency apparatus access, travel time to nearest serving fire station, structural ignitability, building and structure set back, ignition-resistive building features, fire protection systems and equipment, impacts to existing emergency services, defensible space and vegetation management.

The FPP shall be prepared as prescribed in the County of San Diego Land Use and Environment Group "Guidelines for Determining Significance and Report Format and Content Requirements for Wildland Fire and Fire Protection" document.

**SEC. 4905. WILDFIRE PROTECTION BUILDING CONSTRUCTION.**

Section 4905 of the California Fire Code is revised to read:

**SECTION 4905  
WILDFIRE PROTECTION BUILDING CONSTRUCTION**

**Sec. 4905.1 Construction methods for exterior wildfire exposure.** The construction methods for exterior wildfire exposure in a wildland-urban interface fire area shall be as provided in Chapter 7A of the County Building Code.

**SEC. 4907. DEFENSIBLE SPACE.**

Section 4907 of the California Fire Code is revised to read:

**SECTION 4907  
DEFENSIBLE SPACE**

**Sec. 4907.1 Building and Structure setbacks from property lines.** The building official shall establish the minimum setbacks for locating a building and structure on a lot in a wildland-urban interface fire area. The setbacks may be greater than the minimum setbacks provided in the County Zoning Ordinance, when necessary to protect a building and structure from an unreasonable hazard from a wildfire.

**Sec. 4907.1.1 General fire setbacks.** Buildings and structures shall be setback a minimum of 30 feet from property lines and biological open space easements unless existing permitted buildings and structures are located within 30 feet of the property line or the County Zoning Ordinance requires a greater minimum. When the property line abuts a roadway, the setback shall be measured from the centerline of the roadway.

**Exception:** When both the building official and the FAHJ determine that the hazard from a wildland fire is not significant or when the terrain, parcel size or other constraints on the parcel make the required setback infeasible, the building official may allow the setback to be less than 30 feet when allowed by the Zoning Ordinance.

**Sec. 4907.1.2 Fire setbacks adjacent protected areas.** Buildings and structures shall be setback a minimum of 100 feet from any property line adjacent to a national forest, state park or open space preserve. This setback may be reduced when existing permitted buildings and structures are located within 100 feet of the property line or additional mitigation measures are employed that are satisfactory to both the FAHJ and the building official.

**Sec. 4907.1.3 Building and Structure setback from slope.** Single-story buildings and structures shall be setback a minimum 15 feet horizontally from top of slope to the farthest projection from a roof. A single-story building and structure shall be less than 12 feet above grade. A two-story building and structure shall be setback a minimum of 30 feet horizontally from top of slope to the farthest projection from a roof. Buildings and structures greater than two stories may require a greater setback when the slope is greater than 2 to 1.

**Sec. 4907.2 Fuel modification.** A fuel modification zone shall be required around every building that is designed primarily for human habitation or use or a building designed specifically to house farm animals. Decks, sheds, gazebos, freestanding open-sided shade covers and similar accessory structures less than 250 square feet and 30 feet or more from a dwelling, and fences more than 5 feet from a dwelling, are not considered structures for the establishment of a fuel modification zone. A fuel modification zone shall comply with the following:

- a. When a building or structure in a hazardous fire area is located 100 feet or more from the property line, the person owning or occupying the building or structure shall maintain a fuel modification zone within 100 feet of the building or structure. The area within 50 feet of a building or structure shall be cleared of vegetation that is not fire resistant and re-planted with fire-resistant plants. In the area between 50 to 100 feet from a building, all dead and dying vegetation shall be removed. Native vegetation may remain in this area provided that the vegetation is modified so that combustible vegetation does not occupy more than 50% of the square footage of this area. Weeds and annual grasses shall be maintained at a height not to exceed 6 inches. The chips from chipping of vegetation that is done on-site may remain if the chips are dispersed so they do not exceed 6 inches in depth. Trees may remain in both areas provided that the horizontal distance between crowns of adjacent trees and crowns of trees and structures is not less than 10 feet. See Figure 4907.2.
- b. The fire code official may increase the fuel modification zone more than the 100 foot minimum if fuel and/or topography are determined to increase the fire hazard severity.
- c. When a building or structure in a hazardous fire area is setback less than 100 feet from the property line, the person owning or occupying the building or structure shall meet the requirements in subsection (a) above, to the extent possible, in the area between the building or structure and the property line.

- d. The building official and the FAHJ may provide lists of prohibited and recommended plants.
- e. The fuel modification zone shall be located entirely on the subject property unless approved by the FAHJ. This required fuel modification zone may be reduced as allowed in subsection (c) above or increased as required by a fire protection plan.
- f. When the subject property contains an area designated to protect biological or other sensitive habitat or resource, no building or other structure requiring a fuel modification zone shall be located so as to extend the fuel modification zone into a protected area.
- g. Improved Property: Property owners shall be permitted to clear all flammable vegetation within a one hundred (100) foot radius of all buildings using methods, such as mowing and trimming that leave plant root structure intact to stabilize soil. Clearing is not limited to these methods and discing, which exposes bare mineral soil, may be used if deemed necessary by the FAHJ.
- h. Where the distance from the structure to the property line of the parcel on which the building is located is less than the distance required to be cleared, (100'), the adjacent parcel owner may be required to establish the required fuel break to achieve the required distance of defensible space if such requirement is approved by the Fire Code Official.

**FIGURE 4907.2 MEASUREMENTS OF FUEL MODIFICATION DISTANCE**

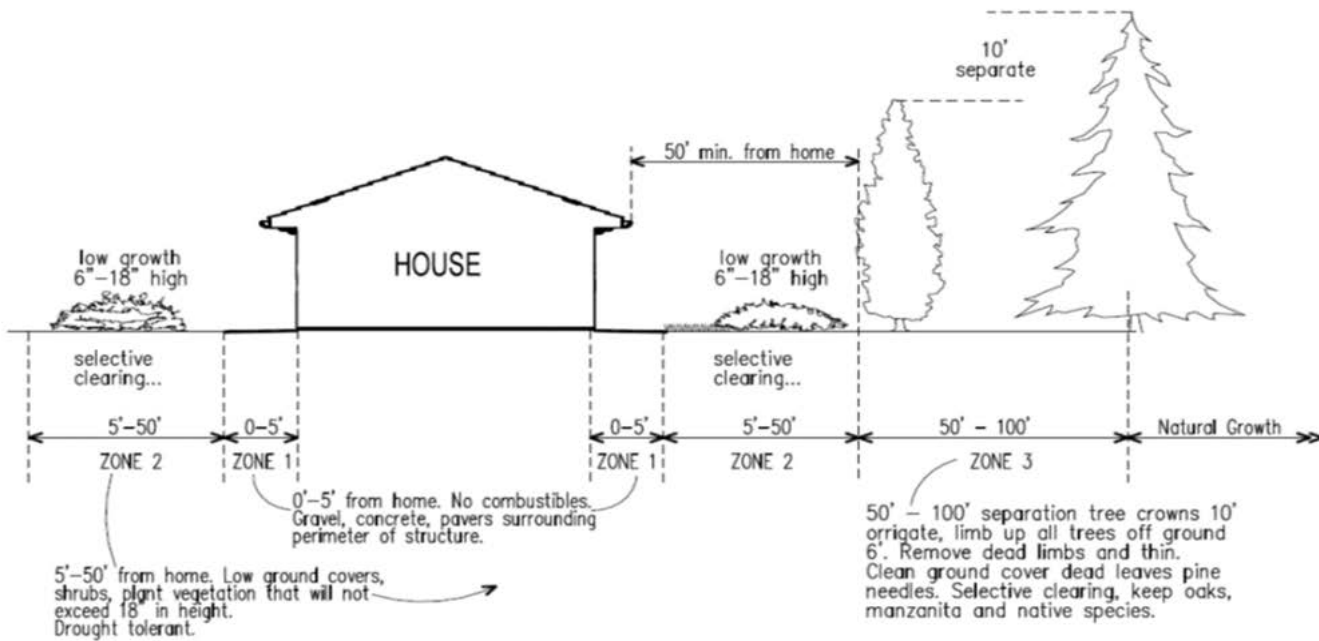

**Sec. 4907.2.1 Fuel modification of combustible vegetation from sides of roadways.** The FAHJ may require a property owner to modify combustible vegetation in the area within 20 feet from each side of the driveway or a public or private road adjacent to the property to establish a fuel modification zone. The FAHJ has the right to enter private property to ensure the fuel modification zone requirements are met.

**Exception:** The FAHJ may reduce the width of the fuel modification zone if it will not impair access.

**Sec. 4907.2.2 Community fuel modification.** The FAHJ may require a developer, as a condition of issuing a certificate of occupancy, to establish one or more fuel modification zones to protect a new community by reducing the fuel loads adjacent to a community and buildings within it. The developer shall assign the land on which any fuel modification zone is established under this section to the association or other

common owner group that succeeds the developer as the person responsible for common areas within the community.

**Sec. 4907.2.2.1 Land ownership.** Once a fuel modification zone has been established under section 4907.2.2 the land on which the zone is located shall be under the control of an association or other common ownership established in perpetuity, for the benefit of the community to be protected.

**Sec. 4907.3 Maintenance of defensible space.** Any person owning, leasing, controlling, operating or maintaining a building or structure required to establish a fuel modification zone pursuant to section 4907.2 shall maintain the defensible space. The FAHJ may enter the property to determine if the person responsible is complying with this section. The FAHJ may issue an order to the person responsible for maintaining the defensible space directing the person to modify or remove non-fire resistant vegetation from defensible space areas, remove leaves, needles and other dead vegetative material from the roof of a building, maintain trees as required by section 4907.3.1 or to take other action the FAHJ determines is necessary to comply with the intent of sections 4903 et seq.

**Sec. 4907.3.1 Trees.** Crowns of mature trees located within defensible space shall maintain a minimum horizontal clearance of 10 feet for fire resistant trees and 30 feet for non-fire resistive trees. Mature trees shall be pruned to remove limbs to maintain a vertical separation of three times the height of the lower vegetation or 6 feet, whichever is greater, above the ground surface adjacent to the trees. Dead wood and litter shall be regularly removed from trees. Ornamental trees shall be limited to groupings of 2-3 trees with canopies for each grouping separated horizontally as described in Table 4907.3.1.

**TABLE 4907.3.1  
DISTANCE BETWEEN TREE CANOPIES**

Distance between Tree Canopies by Percent Slope	
Percent of Slope	Required Distances Between Edge of Mature Tree Canopies (1)
0 to 20	10 feet
21 to 40	20 feet
41 plus	30 feet

*Determined from canopy dimensions as described in Sunset Western Garden Book (Current Edition)*

**Sec. 4907.3.2 Orchards, groves or vineyards.** All orchards, groves and vineyards shall be kept in a healthy state and free of combustible debris and vegetation, including dead or downed trees. A 10-foot firebreak shall be cleared around the perimeter of any orchard, grove or vineyard. Dead grasses between rows of trees or vines shall be mowed.

**Sec. 4907.3.3 Eucalyptus forests and oak woodlands.** All forests and woodlands shall be kept in a healthy state and maintained as described below. The forest or woodlands shall be free of all dead, dying, or diseased trees (excluding tree stumps no higher than six inches above the ground). Dead, dying, or diseased trees shall include insect infested trees, no longer living, in the last stages of growth or infected by a pathogen of any type. If combustible vegetation is located underneath a tree’s drip line, the lowest branch shall be at least three times as high as the understory brush or grasses, or ten feet, whichever is greater. This will reduce the build-up of “ladder” fuels. Firewood shall be neatly stacked and shall have a minimum of 30 feet of clearance (no vegetation) around the entire firewood storage area. Debris and trimmings produced by the removal process shall be removed from the site, or if left, shall be converted into mulch by a chipping machine and evenly dispersed to maximum depth of six inches.

**Sec. 4907.4 Home Ignition Zones:**

**Sec. 4907.4.1 Zone 1 Immediate Zone 0-5’** Meaning from exterior wall surface of the building extending 5 feet on a horizontal plane. This zone shall be constructed of continuous hardscape or limited fire resistant plantings acceptable to the FAHJ. Vegetation in this zone shall not exceed 6” to 18” in height and irrigation is required. Removal of combustible materials surrounding the exterior wall area and

maintaining area free and clear of combustible materials. The use of mulch and other combustible materials shall be prohibited.

**Sec. 4907.4.2 Zone 2 Intermediate Zone from Zone 5' to 50'** means from the immediate edge of zone 1 extending out in a horizontal plane. This zone shall consist of planting of low growth, drought tolerant and fire resistive plant species. The height of the plants in this zone starts at 6" adjacent to Zone 1 and extending in a linear fashion up to a maximum of 18" at intersection with Zone 3. Vegetation in this zone shall be irrigated and not exceed 10' in height and shall be moderate in nature. Trees shall not exceed 30' in height and be limited or as approved by the FAHJ. Firewood inside this zone shall be piled minimum of 30' away from all buildings and structures. Cords of firewood shall also be maintained at least 10' from property lines and not stacked under tree canopies drip lines.

**Sec. 4907.4.3 Zone 3 Extended Zone 50'-100'** means from the immediate edge of Zone 2 extending out in a horizontal plane for 50'. This zone consists of planting of drought tolerant and fire resistive plant species of moderate height. Brush and plants shall be limbed up off the ground so the lowest branches are 1/3 height of bush/tree/plant or up to 6' off the ground on mature trees. This area would be considered selective clearing of natural vegetation and dense chaparral by removing a minimum 50% of the square footage of this area.

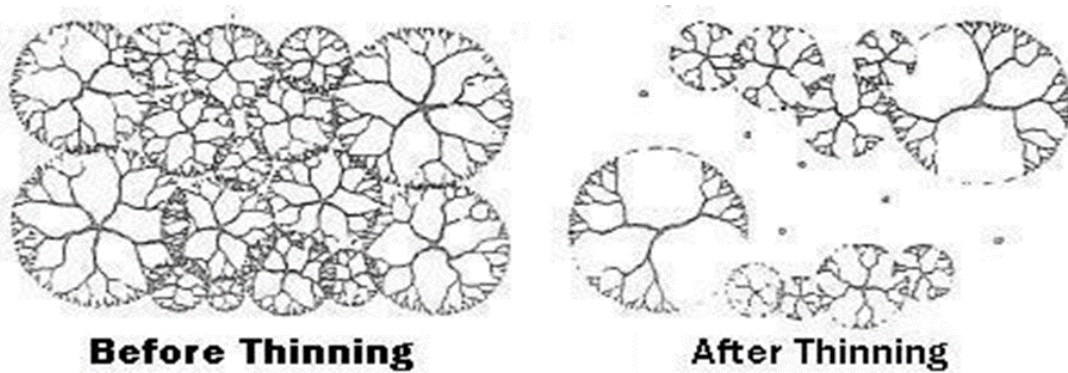

**AMENDMENT TO SECTION 4907.5.**

**Sec. 4907.5 Landscape plans.** New residential custom homes, production tract homes, multi-family residential and commercial buildings shall submit landscape plans to the (insert fire district name) and obtain approval for the plan prior to the framing inspection. Landscape plan submittals shall include a readable scale, the delineation of a 100-foot fuel modification zone, depiction of existing vegetation, all irrigated areas, a plant legend with both botanical and common names and identification of all plant material symbols.

**Sec. 4907.5.1 Landscaping requirements.** All plant materials used shall be from the Wildland/Urban Interface Development Standards plant palette. The addition of plant material to the approved list will be at the discretion of the (insert fire district name). Landscape plans shall be in accordance with the following:

1. All non-fire resistive trees, including conifers, pepper trees, eucalyptus and acacia species, shall be planted and maintained so that the tree's drip line at maturity is a minimum of 30 feet from any combustible structure. All fire resistive tree species shall be planted and maintained at a minimum of 10 feet from the tree's drip line to any combustible structure.
2. For streetscape plantings, all non-fire resistive trees shall be planted so that the center of the tree trunk is 20 feet from edge of curb. Fire resistive trees may be planted 10 feet from edge of curb to center of tree trunk. Care should be given to the type of tree selected so that it will not encroach into the right-of-way or produce a closed canopy effect.

3. Trees and large shrubs shall be limited to groups of two to three trees with mature foliage of any group separated horizontally by at least 10 feet if planted on less than a 20 percent slope and 20 feet if planted on greater than a 20 percent slope.
4. If shrubs are located underneath a tree's drip line, the lowest branch should be at least three times as high as the understory shrubs or 10 feet, whichever is greater.
5. Existing trees may be pruned 10 feet away from roof, eave or exterior siding, depending on the tree's physical or flammable characteristics and a building's construction features.
6. All tree branches and palm fronds shall be removed within 10 feet of a fireplace chimney or outdoor barbecue.

**Sec. 4907.5.2 Landscaping installation.** All landscaping shall be installed prior to final inspection for issuance of certificate of occupancy.

**SEC. 5601.2. EXPLOSIVES AND FIREWORKS-APPLICABILITY.**

Section 5601.2 is added to the California Fire Code to read:

**Sec. 5601.2 Applicability.** This section shall apply to the manufacture, possession, storage, sale, transportation and use of explosives and blasting agents and to any blasting operation in the unincorporated area of the County. The Sheriff is the Issuing Officer for purposes of this section. The Sheriff may delegate the duties of Issuing Officer at her or his discretion. Additionally, as may be appropriate based on circumstances, the Issuing Officer may enter into memoranda of agreement with non-County fire agencies whereby such non-County agency will assume the duties of issuing a permit or permits required by this Chapter. The Issuing Officer shall determine whether a blast is a major blast or a minor blast under this section. A minor blast is subject to all conditions of this section except the inspection requirements.

**Sec. 5601.2.1 Definitions.** The following terms are defined in section 202:

- BLASTER.
- BLASTING AGENT.
- BLASTING OPERATION.
- BLASTING PERMIT.
- BLAST SITE.
- EXPLOSIVES PERMIT.
- INSPECTOR.
- MAJOR BLASTING.
- MINOR BLASTING.

**Sec. 5601.2.2. Application.** Application for a permit required by this section shall be in the form required by the Issuing Officer.

**Sec. 5601.2.3 Permit requirements.** No person shall conduct blasting in the unincorporated area of the County without an explosives permit issued under this chapter. A person applying for an explosives permit shall, in addition to demonstrating compliance with fire safety requirements also comply with all County requirements for any building permits, grading permits, use permits, encroachment permits and all other entitlements to use property, including zoning requirements and any determination under the Zoning Ordinance of non-conforming status. The applicant shall be responsible for providing proof of all necessary approvals when requested by the Issuing Officer.

**Sec. 5601.2.4 Permit conditions.** The Issuing Officer may impose conditions and procedures as are deemed reasonably necessary to protect the public health and safety based upon the facts and circumstances of a particular blasting operation. The permit conditions shall be in writing. Failure to comply with any permit condition is grounds for revocation of the permit. A blaster may request the



Issuing Officer release the blaster from any permit condition if circumstances have changed that make the condition no longer applicable. In addition to complying with the County blasting regulations, a blaster shall also comply with blasting regulations of neighboring jurisdictions, for any blasting operations outside of the unincorporated area of the County conducted in conjunction with a project within the unincorporated areas of the County.

**Sec. 5601.2.5 Insurance and indemnification required.** As an additional condition for obtaining an explosives permit the applicant shall submit: (1) a certificate of insurance evidencing that the blaster has obtained a general liability insurance policy which includes coverage for explosion, collapse and underground property damage from an insurer satisfactory to the Issuing Officer, that is in effect for the period covered by the permit, written on an "occurrence" basis, in an amount of not less than \$500,000 per each occurrence, naming the County and the FAHJ as an additional insured and providing that the policy will not be canceled or terminated without 30 days prior written notice to the County and (2) an agreement signed by the blaster agreeing to defend, indemnify and hold the County and its agents, officers and employees harmless from any claims or actions arising from the issuance of the permit or any blasting activity conducted under the permit.

**Sec. 5601.2.6 Blasting hours.** Blasting shall only be allowed Monday through Saturday, between the hours of 7:00 a.m. and 6:00 p.m. or ½ hour before sunset, whichever occurs first, unless special circumstances warrant another time or day and the Issuing Officer grants approval of the change in time or day.

**Sec. 5601.2.7 Additional operational requirements.** The owner of any property in the unincorporated area of the County on which any blasting is intended to occur, shall give, or cause to be given, a one-time notice in writing, for any proposed blasting to the local fire agency and dispatch center and to all residences, including mobile homes, and businesses within 600 feet of any potential major blast location or 300 feet from any potential minor blast location. The notice shall be given not less than 24 hours, but not more than one week, before a blasting operation and shall be in a form approved by the Issuing Officer. The minimum 24-hour notice requirement may be reduced to a lesser period but not less than one hour if the Issuing Officer determines that special circumstances warrant the reduction in time. Adequate precautions shall be taken to reasonably safeguard persons and property before, during and after blasting operations. These precautions shall include:

1. The blaster shall retain an inspector to inspect all buildings and structures, including mobile homes, within 300 feet of the blast site before blasting operations, unless inspection is waived by the owner and/or occupant. The inspector shall obtain permission of the owner and/or occupant before conducting the inspection. The inspection shall be only for the purpose of determining the existence of any visible or reasonably recognizable preexisting defects or damages in any building and structure. Waiver of inspection shall be in writing signed by the owner and/or occupant. Refusal to allow inspection shall also constitute a waiver. The inspector shall notify the owner and/or occupant of the consequences of refusing an inspection shall include a refusal in the summary report filed with the Issuing Officer. The blaster shall request an inspector conduct post-blast inspections upon receipt of a written complaint of property damage if the complaint is made within 60 days of completion of blasting operations. If the blaster has knowledge of alleged property damage independent of the written complaint, the blaster shall also retain an inspector to conduct a post-blast inspection.
2. An inspector shall complete and sign pre-blast- inspection reports identifying all findings and inspection waivers. The blaster shall retain the inspection reports for three years from the date of the blasting and upon a complaint of alleged damage the blaster shall immediately file a copy of the report with the Issuing Officer and provide a copy to the complainant. If there is a change in the blasting contractor after blasting has commenced on a project, a re-inspection shall be conducted in accordance with the preceding paragraph before the new blasting contractor undertakes any additional blasting.

3. The blaster shall retain an inspector to conduct a post-blast- inspection of any building and structure for which a written complaint alleging blast damage has been received. A written report of the inspection shall be immediately filed with the Issuing Officer and provided to any person who made a complaint for damages.
4. The blaster shall allow any representative of the Issuing Officer to inspect the blast site and blast materials or explosives at any reasonable time.
5. If the blaster wants a representative of the Issuing Officer to witness a blasting operation the blaster shall make a request with the Issuing Officer at least 12 hours before the blast. The blaster shall confirm the request for a witness with the Issuing Officer at least one hour before the blast. The blaster shall be responsible for any cost incurred by the Issuing Officer in having a representative witness the blast.
6. The blaster shall notify the Issuing Officer on the day of a scheduled blasting operation not less than one hour before blasting.
7. All major blasting operations shall be monitored by an approved seismograph located at the nearest building and structure within 600 feet of the blasting operation. All daily seismograph reports shall be maintained by the blaster for three years from the blasting.

**Sec. 5601.2.8 Seizure of illegal items.** The Issuing Officer may seize at the owner’s expense, all explosives, ammunition or blasting agents, which are illegally manufactured, sold, offered or exposed for sale, delivered, stored, possessed or transported in violation of this chapter.

**Sec. 5601.2.9 Violations for false or misleading information.** It shall be unlawful and a violation of this chapter for any person to provide false or misleading information or documentation to the County or any of its officers or employees or to any fire department, fire protection district, fire company or legally formed volunteer fire department, or its officers or employees in the unincorporated area of the County, having jurisdiction over any aspect of the explosives or blasting permit process or blasting operations.

**Sec. 5601.2.10 Fees.** A person applying to the Issuing Officer to be approved as a blaster or inspector, as defined in this section, shall pay an application fee to the Issuing Officer. A person applying for an explosives permit under this section shall pay the fee established by the Issuing Officer with the application. The amount of any fee required by this chapter shall be determined by the Issuing Officer on the basis of the full costs involved in processing an application.

**SEC. 5608.1. FIREWORKS DISPLAY.**

Section 5608.1 of the California Fire Code is revised to read:

**Sec. 5608.1 General.** Outdoor fireworks displays, use of pyrotechnics before a proximate audience and pyrotechnic special effects in motion picture, television, theatrical and group entertainment productions shall comply with California Code of Regulations, Title 19, Chapter 6 Fireworks and County Code sections 32.101 et seq. The Fire Warden is the Issuing Officer for any fireworks permit required by this Chapter. The Fire Warden may delegate the duties of Issuing Officer at her or his discretion. Additionally, as may be appropriate based on circumstances, the Issuing Officer may enter into memoranda of agreement with non-County fire agencies whereby such non-County agency will assume the duties of issuing a permit or permits required by this Chapter.

**Sec. 5608.1.1 Scope.** The possession, manufacture, sale, storage, use and display of fireworks are prohibited in the unincorporated area of the County except as provided in County Code sections 32.101 et seq.

**SEC. 5705.2.4. TRANSFERRING CLASS I, II OR III LIQUIDS.**

Section 5705.2.4 of the California Fire Code is revised to read:

**Sec. 5705.2.4 Transferring Class I, II or III liquids.** Class I or II liquids or Class III liquids that are heated up to or above their flash points shall be transferred by one of the following methods:

1. From safety cans complying with UL 30.
2. Through an approved closed piping system.
3. From containers or tanks by an approved pump taking suction through an opening in the top of the container or tank.
4. Approved engineered liquid transfer system.

**Exception:** Liquids in containers not exceeding a 5.3-gallon (20 L) capacity.

**SEC. 5706.2.5.2.1 TANKS FOR GRAVITY DISCHARGE.**

Section 5706.2.5.2.1 of the California Fire Code is added to read:

**Sec. 5706.2.5.2.1 Limitations on tanks for gravity discharge.** Gravity dispensing of Class I or II liquids or Class III liquids that are heated up to or above their flash points is prohibited. Dispensing devices for flammable and combustible liquids shall be of an approved type. Approved pumps taking suction from the top of the tank shall be used. Flammable or combustible liquids shall not be dispensed by a device that operates through pressure within a storage tank. Air or oxygen shall not be used to pressurize an aboveground tank.

**SEC. 5706.2.8.2 PROHIBITION ON USE OF TANK VEHICLE.**

Section 5706.2.8.2 is added to the California Fire Code to read:

**Sec. 5706.2.8.2 Tank vehicle as a substitute for permanent tank prohibited.** The use of a tank vehicle in a stationary manner as a substitute for an approved above-ground or below-ground fuel tank is prohibited.

**SEC. 6107.5. SAFETY PRECAUTIONS AND DEVICES-SECURING LPG TANKS.**

Section 6107.5 is added to the California Fire Code to read:

**Sec. 6107.5 Securing LPG tanks.** When required by the FAHJ, LPG tanks shall be secured to prevent the tank from rolling or moving.

**SEC. 8001. REFERENCED STANDARDS.**

Section 8001 is added to the California Fire Code to read:

**Sec. 8001. Referenced standard NFPA 13D.** Amended sections as follows:

**Revise 5.1.1.2 to read as follows:**

**5.1.1.2 Spare sprinkler heads.** Spare fire sprinkler heads (one of each type or as approved by the FAHJ) wrench, inspectors test key and operation and maintenance instructions shall be provided in the vicinity of the riser.

**Add a new 7.1.5 to read as follows:**

**7.1.5 Pressure-reducing valve.** If maximum static pressure from the water supply exceeds 130 psi, a pressure-reducing valve acceptable to the FAHJ shall be installed before the system riser. If pressure reducing valves are installed a pressure relief valve shall be installed and set at 175psi. When such valves are installed submittal documents must include manufacturer information sheets along with charts showing the dimensions (size) and flow characteristics inlet and outlet pressures at various flows for the type of valve being installed, and the valve shall be included in the design calculations.

**Revise 7.2.5 to read as follows:**

**7.2.5 Inspector Test.** Each automatic sprinkler system shall have a ½" or larger test connection with a threaded keyless valve. The valve shall be remote to the riser, located on the building exterior about five 5 feet above final grade. It shall be labeled with a permanent plate with minimum ¼" lettering, contrasting

with background, and stating: "INSPECTOR TEST". (Pre-assembled riser assemblies with a built-in Drain/Test valve shall not be accepted for inspector test valve unless approved by the FAHJ.)

**Add a new 7.3.4 to read as follows:**

**7.3.4 Pressure gauge.** An approved 300 psi pressure gauge shall be permanently installed at the riser.

**Revise 7.6 to read as follows:**

**7.6 Alarms.** A water flow switch shall be provided and located on the sprinkler riser above the check valve and main drain and shall actuate an audible fire alarm signal bell and may be required to be interconnected to the interior smoke alarms. The water flow switch shall be a retarding type with a delay between 15-60 seconds before activation of the signal bell. Alarm bell shall have a minimum diameter of 8 inches and be mounted on the exterior in the vicinity of the master bedroom. The alarm bell shall be clearly audible in all bedrooms with intervening doors closed.

**Revise 8.3.2 to read as follows:**

**8.3.2** Sprinklers are not required in bathrooms where the area does not exceed 55 sq. ft. unless there is door exiting directly to the outside, and the walls and ceilings including behind fixtures, are of noncombustible or limited combustible materials providing a fifteen-minute thermal barrier.

**Revises or adds the following sections to read as follows:**

**8.3.3.** Sprinklers shall not be required in clothes closets, linen closets, and pantries that meet the following conditions:

1. The area of the space does not exceed 24 sq. ft.
2. The shortest dimension does not exceed 3 ft.
3. The walls and ceilings are surfaced with noncombustible or limited-combustible materials as defined in NFPA 220.
4. The closet does not contain any type of electrical items such as light fixtures, electrical outlets or low voltage equipment.

**Revise 8.3.4 to read as follows:**

**8.3.4.** Sprinklers shall be installed in garages, carports and similar structures unless they meet the exception in sec. 903.2.2.1. Covered patios, decks, balconies or similar projections that extend 10 feet or more from the structure will require adequate fire sprinkler coverage.

**Revise 8.3.5.1.1 to read as follows:**

**8.3.5.1.1.** Where the fuel-fired equipment is above all of the occupied areas of the dwelling unit, at least one quick-response intermediate temperature sprinkler shall be installed above the equipment.

Revise 8.3.10 to read as follows:

**8.3.10.** Sprinklers shall be installed in saunas and wine rooms.

Add a new 10.2.4.1 to read as follows:

**10.2.4.1 3-Head Calculation.** When design conditions exceed the allowances of sec. 10.2, a 3-head calculation may be required by the FAHJ.

**Add a new 10.2.5 to read as follows:**

**10.2.5 Pressure Cushion.** The system shall be designed 10% below available water source pressure during peak usage.

**Revise 11.2.1.1 to read as follows:**

**11.2.1.1 Hydrostatic Tests.** Where a fire department connection is not provided, the system shall be hydrostatically tested at 200 psi for 2 hours.

**Revised 12.3.6 to read as follows:**

**12.3.6 Inactive Systems.** When automatic sprinkler systems are shut-off or otherwise inoperative for periods greater than 48 hours for repair of service, the FAHJ must be notified immediately.

**SEC. APP.B103.3. AREAS WITHOUT WATER SUPPLY SYSTEMS.**

Appendix B, section B103.3 of the California Fire Code is revised to read:

**B103.3 Areas without water supply systems.** For information regarding water supplies for fire-fighting purposes in rural areas and suburban areas in which adequate and reliable water supplies do not exist, the fire code official is authorized to utilize NFPA 1142 or the standard published by the Insurance Services Office document entitled "Guide for Determination of Required Fire Flow."

**SEC. APP.H100 REPORTING FORMS**

Appendix H, sec. H100 is added to the California Fire Code to read:

**SECTION H100  
REPORTING FORMS**

**H100.1 Reporting forms.** Hazardous Materials reporting forms currently adopted by San Diego County Department of Environmental Health Hazardous Materials Management Unit which cover the same areas as forms contained in this Appendix are adopted by reference and take precedence over this Appendix.

**Section 4**

The geographic limits referred to in certain sections of the 2019 California Fire Code are established as follows:

- a. **Sec. 5704.2.9.6.1.** The geographic limits in which the storage of Class I and Class II liquids in above-ground tanks outside of buildings is prohibited and hereby established in the jurisdictional limits of the Rancho Santa Fe Fire Protection District.

**Exceptions:**

- 1. In areas zoned for mixed, general or high impact industrial uses.
- 2. Crankcase draining may be stored in specially constructed above-ground storage tanks, approved by the fire code official, with a maximum capacity of 550 gallons. These tanks may be located within a building when the fire code official deems appropriate and the container meets U.L. Standard 2085. Containers shall be installed and used in accordance with their listing and provisions shall be made for leak and spill containment. In no case shall storage be allowed on residential or institutional property.
- 3. With the fire code official's approval, Class I and II liquids may be stored above ground outside of buildings in specially designed, approved and listed containers which have features incorporated into their design which mitigate concerns for exposure to heat, ignition sources and mechanical damage. Containers shall be installed and used in accordance with their listing, and provisions shall be made for leak and spill containment. The fire code official may disapprove the installation of these containers when in his or her opinion their use presents a risk to life or property.

- b. **Sec. 5706.2.4.4.** The geographic limits in which the storage of Class I and Class II liquids in above-ground tanks is prohibited and hereby established in the jurisdictional limits of the Rancho Santa Fe Fire Protection District.

**Exceptions:**

- 1. In areas zoned for other than residential uses, when approved by the FAHJ.

2. Crankcase draining may be stored in specially constructed above-ground storage tanks, approved by the fire code official, with a maximum capacity of 550 gallons. These tanks may be located within a building when the fire code official deems appropriate and the container meets U.L. Standard 2085. Containers shall be installed and used in accordance with their listing, and provisions shall be made for leak and spill containment. In no case shall storage be allowed in residential or institutional property.
  3. With the fire code official's approval, Class I and II liquids may be stored above ground in specially designed, approved and listed containers which meet U.L. Standard 2085. Containers shall be installed and used in accordance with their listing, and provisions shall be made for leak and spill containment. The fire code official may disapprove the installation of such containers when in his opinion their use presents a risk to life or property.
- c. **Sec. 5806.2.** The geographic limits in which the storage of flammable cryogenic fluids in stationary containers is prohibited and hereby established in the jurisdictional limits of the Rancho Santa Fe Fire Protection District, except for areas zoned for mixed, general or high impact industrial uses.
  - d. **Sec. 6104.2.** The geographic limits in which the bulk storage of liquefied petroleum gas is prohibited for the protection of heavily populated and congested areas and is hereby established in the jurisdictional limits of the Rancho Santa Fe Fire Protection District, except for areas zoned for mixed, general or high impact industrial uses.

**Exception:** Bulk tanks with a maximum aggregate capacity of 30,000 gallons water capacity for above-ground storage of underground distribution to residential areas, where the storage and distribution meets Fire Code requirements as determined by the FAHJ.

## Section 5

That if any section, subsection, sentence, clause or phrase of this ordinance is, for any reason, held to be unconstitutional, such decision shall not affect the validity of the remaining portions of this ordinance. The Board of Directors hereby declares that it would have passed this ordinance, and each section, subsection, clause, or phrase thereof, irrespective of the fact that any one or more sections, subsections, sentences, clauses, and phrases be declared unconstitutional.

## Section 6

That nothing in this ordinance or in the 2019 California Fire Code hereby adopted shall be construed to affect any suit or proceeding impending in any court, or any rights acquired, or liability incurred, or any cause or causes of action acquired or existing, under any act or ordinance hereby repealed as cited in Section 1 of this ordinance; nor shall any just or legal right or remedy of any character be lost, impaired or affected by this ordinance.

## Section 7

That the Clerk of the Board of Directors is hereby ordered and directed to cause this ordinance to be published. First read at a special (in lieu of regular) meeting of the Board of Directors of the Rancho Santa Fe Fire Protection District, held on the September 25, 2019. A second reading occurred at a regular meeting on October 16, 2019 and finally adopted and ordered published in the manner required by law at the hearing and meeting on November 20, 2019 by the following roll call vote:

AYES:

NOES:

ABSENT:

ABSTAIN:

Upon passage, the Secretary of the Board shall transmit a copy of this Ordinance to the California Building Standards Commission pursuant to Health and Safety Code section 17958.7.

**Section 8**

That this ordinance and the rules, regulations, provisions, requirements, orders, and matters established and adopted hereby shall take effect and be in full force no earlier than 30 days from and after the date of its final passage and adoption. This ordinance shall become effective January 1, 2020.



James H. Ashcraft  
President

ATTEST:



Karlena Rannals  
Secretary

## FINDINGS

### FOR REVISION OF THE RANCHO SANTA FE FIRE PROTECTION DISTRICT AMENDMENTS TO THE 2019 CALIFORNIA FIRE CODE OF THE CALIFORNIA CODE OF REGULATIONS TITLE 24, PART 9

As required by Health and Safety Code section 17958 the Rancho Santa Fe Fire Protection District does herewith make express findings that amendments to the 2019 California Fire Code are necessary for the protection of the public health, safety, and welfare due certain climatic, topographic, or geological features existing in the County of San Diego.

The following matrix lists the Rancho Santa Fe Fire Protection District amendments and the corresponding express findings. Minor editorial changes or typographical corrections to the Fire Code are not shown in these findings. The full texts of the proposed Rancho Santa Fe Fire Protection District amendments are shown in Rancho Santa Fe Fire Protection District Fire Code.

#### **Additional Findings for Chapter 49**

#### **REQUIREMENTS FOR WILDLAND-URBAN INTERFACE FIRE AREAS**

As required by Health and Safety Code section 17958 the Rancho Santa Fe Fire Protection District Board of Directors does herewith make express findings that amendments to the California Building Standards Code are necessary for the protection of the public health, safety and welfare due certain climatic, topographic or geological features existing in the County of San Diego of San Diego.

#### **DEFINITIONS:**

**CLIMATE.** The average course or condition of the weather at a particular place over a period of many years, as exhibited in absolute extremes, means and frequencies of given departures from these means (i.e., of temperature, wind velocity, precipitation and other weather elements).

**TOPOGRAPHY.** The configuration of landmass surface, including its relief (elevation) and the position of its natural and man-made features that affect the ability to cross or transit a terrain.

**GEOGRAPHY.** A science that deals with the earth and its life, especially the description of land, sea, air, and the distribution of plant and animal life including man and his industries with reference to the mutual relations of these diverse elements. Webster's Third New California Dictionary

#### **CLIMATIC CONSIDERATIONS:**

There are two types of climates: macro and micro. A macro climate affects an entire region and gives the area a general environmental context. A micro climate is a specific variation that could be related to the other two factors, topography and geography. A micro climate may cover a relatively small area or be able to encompass an entire community, as opposed to another community in the same County of San Diego.

Climatic consideration should be given to the extremes, means, and anomalies of the following weather elements:

1. Temperatures.
2. Relative humidifies.
3. Precipitation and flooding conditions.
4. Wind speed and duration of periods of high velocity.
5. Wind direction.
6. Fog and other atmospheric conditions.



**TOPOGRAPHIC CONSIDERATIONS:**

Topographic considerations should be given to the presence of the following topographical elements:

1. Elevation and ranges of elevation.
2. Location of ridges, drainages and escarpments.
3. Percent of grade (slope).
4. Location of roads, bridges and railroads.
5. Other topographical features, such as aspect exposure.

This information becomes an important part of creating an analysis of urban-wildland areas because topography and slope are key elements (along with fuel type) that create the need for specific ignition-resistance requirements in this code

**GEOGRAPHIC CONSIDERATIONS:**

Geography should be evaluated to determine the relationship between man-made improvements (creating an exposure) and factors such as the following:

1. Fuel types, concentration in a mosaic and distribution of fuel types.
2. Earthquake fault zones.
3. Hazardous material routes.
4. Artificial boundaries created by jurisdictional boundaries.
5. Vulnerability of infrastructure to damage by climate and topographical concerns.

## Findings for the Fire Code

### Finding 1

The Rancho Santa Fe Fire Protection District is situated on the slopes of and at the base of the Coastal Mountains, with drainage from the eastern portion of the district, including the San Dieguito River and Escondido Creek, which when flooded, could result in conditions rendering fire departments vehicular traffic access unduly burdensome or impossible.

Furthermore, the flood conditions described above possess the potential for overcoming the ability of the fire department to aid or assist in fire control, evacuations, rescues and the emergency demands inherent in such situations. The potential for the aforementioned flooding conditions can result in limiting the fire department emergency vehicular traffic, which can result in overtaxing the fire department personnel, and may further cause a substantial or total lack of protection against fire for the buildings and structures located within the jurisdiction.

### Finding 2

The Rancho Santa Fe Fire Protection District is situated near several known major faults, each capable of generating earthquakes of significant magnitude. These include the Rose Canyon Fault, the Coronado Banks, and the Silver Strand Faults, located generally west of the District and the Elsinore Fault, the Agua Caliente Fault, located east of the District. These faults are subject to becoming active at any time; the Rancho Santa Fe Fire Protection District is particularly vulnerable to devastation should such an earthquake occur.

The potential effects of earthquake activity could isolate the Rancho Santa Fe Fire Protection District from the surrounding areas as well as restrict or eliminate internal circulation routes. The potential exists for the collapse of highway overpasses and underpasses, along with other bridges in the district. Rendering surface travel unduly burdensome or impossible.

### Finding 3

San Diego County Highway S6 bisects the Rancho Santa Fe Fire Protection District. Transportation vehicles carrying known toxic, flammable, explosive, and hazardous materials travel this highway.

The potential for release or threatened release of a hazardous material along this route and others within the district is likely given the volume transported daily. Incidents of this nature will normally require all available emergency response personnel to prevent injury, loss of life and property loss. Emergency personnel responding to such incidents may become impeded and delayed.

### Finding 4

Much of the rural area of the Rancho Santa Fe Fire Protection District is mountainous topography and lacks the infrastructure needed to supply enough available water supply for fire hydrants. Those conditions have adversely impacted the water availability for firefighting. Fires starting in sprinklered buildings are typically controlled by one or two sprinkler heads, flowing as little as 13 gallons per minute.

Hose streams used by engine companies on well-established structure fires operate at about 130 gallons per minute, and the estimated water needed for a typical residential fire is between 1,250 to 1,500 gallons per minute.

Under circumstances such as, lack of water infrastructure, earthquakes, multiple fires and wildland fires within a community, the limited water demand needs of residential fire sprinklers would control and extinguish many fires before they spread from building to wildland. In such a disaster, water demands needed for conflagrations probably would not be available.

**Finding 5**

The topography of the Rancho Santa Fe Fire Protection District presents problems in delivery of emergency services, including fire protection. The mountainous terrain has narrow winding roads with very little circulation, preventing rapid access and orderly evacuation. Much of these hills are covered with highly combustible natural vegetation. In addition to access and evacuation problems, the terrain makes delivery of water extremely difficult. Some areas are served by water pump systems which are subject to fail in power outage situations such as fire, high winds, and earthquakes. This situation would only allow domestic gravity fed water from tanks and not enough water for firefighting.

**Finding 6**

Due to the mountainous topography in much of the rural area of the Rancho Santa Fe Fire Protection District, roadway conditions, gates, angle of approach or departure, steeply sloping roadways and grades are common. It is very important that roadways be named and identified in order to facilitate an emergency response. Street signage should be posted and clearly visible at all times.

**Finding 7**

Due to the mountainous topography in much of the rural area of the Rancho Santa Fe Fire Protection District, steep, narrow and winding roads as well as areas of heavy brush are common. These features make it difficult for emergency response personnel to easily and quickly find the location of the site that requires assistance. It is therefore essential that street numbers be readily visible from the street or road fronting the property to ensure quick response times from emergency personnel for a given location.

**Finding 8**

Due to access and mountainous topography in much of the Rancho Santa Fe Fire Protection District, difficult roadway conditions, gates, angles of approach or departure, steeply sloping roadways and grades are common. In addition, heavy rainstorms and ground water retention in many areas of the District produces a condition that damages roadways due to soil expansion and shrinkage. All weather, paved surfaces capable of supporting the imposed loads of fire apparatus are necessary to ensure access of emergency response personnel. These roadways, gates, approach angles, steep slopes and grades can also make it difficult for fire apparatus and other emergency vehicles to access a site. It is therefore essential that these roadway accesses be provided with proper all weather, paved surfaces, angle of approach, grades and gate access.

**Finding 9**

Due to the mountainous topography served by most of the Rancho Santa Fe Fire Protection District, conditions exist such as poor water supply, poor access roads, steep grades and steep canyon slopes. The distances emergency response personnel must travel can be excessive and response times can be lengthy. Numerous studies regarding the growth of fire in relation to length of time have proven that at ten minutes the fire is expected to have burned beyond control and any occupants remaining in the burning building would not be expected to survive. A ten-minute response time realistically represents the time in which serious injury or death is expected to occur. Mitigation for extended response times would be in the form of fire sprinklers or increased fire flow.

**Finding 10**

Areas in the Rancho Santa Fe Fire Protection District can have special fire prevention needs which are not addressed in the fire code. This is due to the unique topographical features, demographics, infrastructure and economics of the Fire District.

**Finding 11**

The seasonal climatic conditions during the late summer and fall create numerous difficulties regarding the control of and protection against fires in the Rancho Santa Fe Fire Protection District. The hot, dry weather typical of this

area in summer and fall, coupled with Santa Anna winds and low humidity frequently results in wildfires that threaten or could threaten the Rancho Santa Fe Fire Protection District.

Although some code requirements, such as fire-resistive roof classification, have a direct bearing on building survival in a wildland fire situation, others, such as residential fire sprinklers, may also have a positive effect. In dry climate on days with low relative humidity materials are easily ignited. Fires are likely to occur and any fire, once started, can expand rapidly. Residential fire sprinklers can arrest a fire starting within a structure before the fire is able to spread to adjacent brush and structures. As well as fire resistive landscaping can assist in the prevention of a wildland fire from expanding to a structure.

The seasonal winds have the potential for interfering and delaying emergency vehicle access and response due to the toppling of trees. The trees are subject to uprooting in strong winds due to relatively small root bases compared to the tree height. The aforementioned problems support the imposition of fire-protection requirements greater than those set forth in the Building Code or Fire Code

## ATTACHMENT B

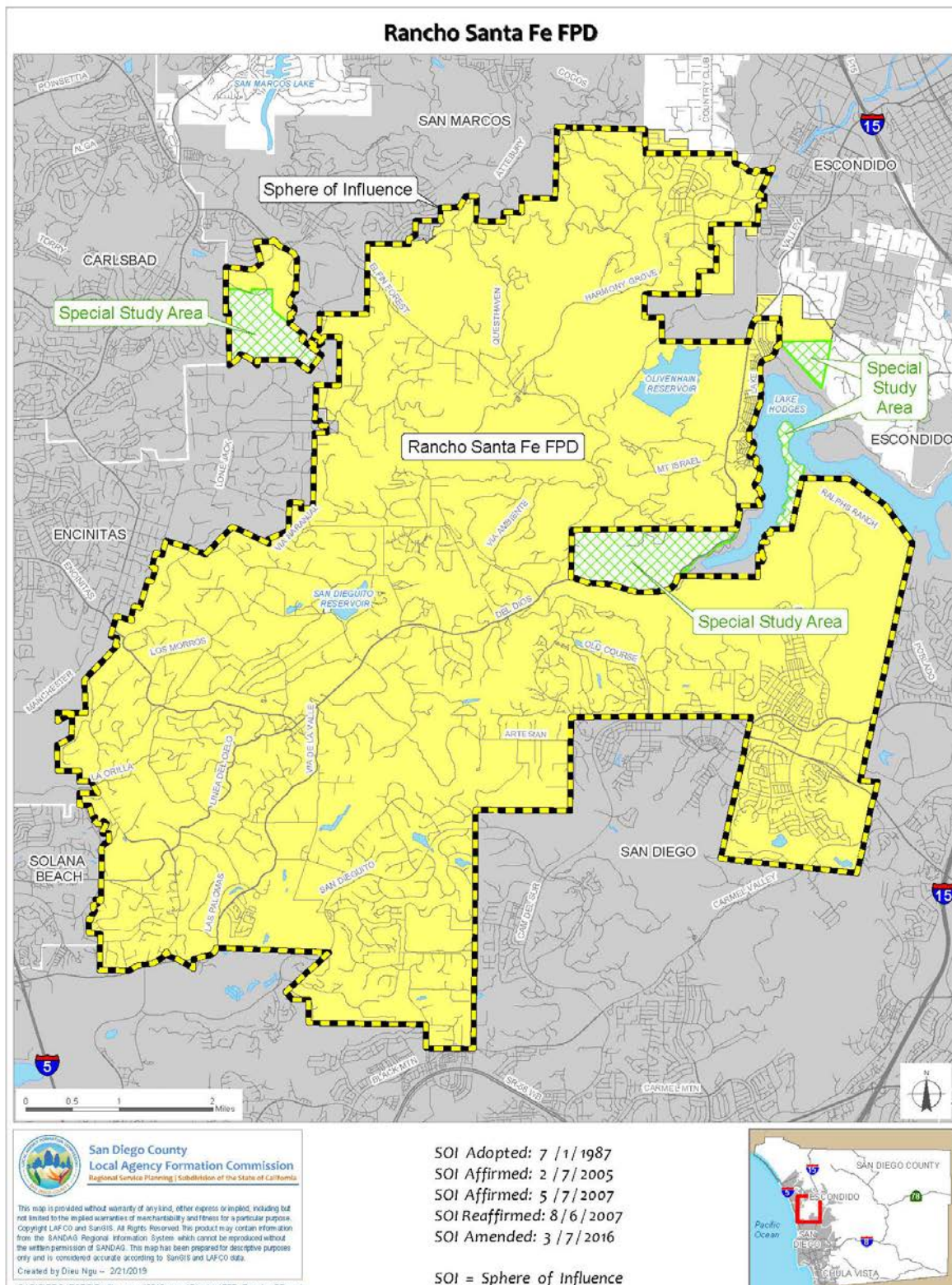

### INDEX BY CODE SECTION CONSOLIDATED FIRE CODE

Differences:

1. Showed the language and text that is different from the California Fire Code and the County Code as shown in Italics.
2. Changed punctuation or a grammatical change.
3. Words were deleted or sections deleted. County amendments were not necessary as section was adopted in model code language.
4. Revised or amended texts. Changes from the previous code that have been revised.
5. NC means no changes made. Language is the same.

County Section Old	County Section New	Subject	Fire District Section Old	Fire District Section New	Difference
Sec. 1.001	Sec 1.001	Application of the CCC			4
Sec. 1.002	Sec 1.002	Explanation of the CCC			4
Sec. 96.1.001	Sec 96.1.001	Adoption of County Amendments to the CFC	Section 2	Section 2	4
Sec. 96.1.002	Sec. 96.1.002	Explanation of CFC to 2019 Fire Code			4
Sec. 96.1.003	Sec. 96.1.003	Explanation of County Fire Code adding 96.1			4
Sec. 96.1.004	Sec 96.1.004	Responsibility for Enforcement			NC
Sec. 96.1.005	Sec. 96.1.005	Geographic Limits			NC
Sec. 96.1.006	Sec. 96.1.006	Deletions, Revisions, Additions and Numerical			4
Sec. 96.1.105.5	Sec. 96.1.105.5	Validity	Sec. 101.5	Sec. 101.5	1
Sec. 96.1.102.13	Sec. 96.1.102.13	Repeal of Conflicting Ordinances, Resolutions or Motions	Sec. 102.13	Sec. 102.13	NC
Sec. 96.1.104.8	Sec. 96.1.104.8	Modifications	Sec. 104.8	Sec. 104.8	1
Sec. 96.1.104.12	Sec. 96.1.104.12	Cost Recovery	Sec. 104.12	Sec. 104.12	NC
Sec. 96.1.105.3.9	Sec. 96.1.105.3.9	Expense Recovery	Sec. 105.3.9	Sec. 105.3.9	NC
Sec. 96.1.105.6.6.1	Sec. 96.1.105.6.6.52	Christmas Tree Lots	Sec. 105.6.6.1	Sec. 105.6.6.52	4
Sec. 96.1.105.6.20.1	Sec. 96.1.105.6.20.1	Greenwaste Recycling, Mulching, Composting & Storage	Sec. 105.6.20.1	Sec. 105.6.20.1	NC
Sec. 96.1.105.8	Sec. 96.1.105.8	New materials, process or Occupancies Require Permits	Sec. 105.8	Sec. 105.8	NC
Sec. 96.1.108	Sec. 96.1.109	Appeals	Sec. 108	Sec. 109	1, 4
Sec. 96.1.109.4	Sec. 96.1.110.4	Violations, Penalties and Responsibilities for Compliance	Sec. 109.4	Sec. 110.4	1, 4
		Failure to Comply	Sec. 111.4	Sec. 112.4	4
Sec. 96.1.202	Sec. 96.1.202	Definitions	Sec. 202	Sec. 202	1,2,4
Sec. 96.1.304.1.4	Sec. 96.1.304.1.4	Outdoor Carnivals and Fairs	Sec. 304.1.4	Sec. 304.1.4	NC

County Section Old	County Section New	Subject	Fire District Section Old	Fire District Section New	Difference
Sec. 96.1.307.5	Sec. 96.1.307.5	Attendance of Open Burning and Recreational Fires	Sec. 307.5	Sec. 307.5	1,4
Sec. 96.1.320	Sec. 96.1.321	Mid-Rise Buildings	Sec. 320	Sec. 321	1, 4
		Mid-Rise General	Sec. 320.1	Sec. 320.1	NC
		Mid-Rise Automatic Sprinkler System & Standpipes	Sec. 320.1.1	Sec. 321.1.1	4
		Mid-Rise Smoke Detection	Sec. 320.1.2	Sec. 321.1.2	4
		Mid-Rise Fire Alarm	Sec. 320.1.3	Sec. 321.1.4	4
		Mid-Rise Emergency Voice Alarm Signaling System	Sec. 320.1.4	Sec. 321.1.4	4
		Mid-Rise Fire Command Center	Sec. 320.1.5	Sec. 321.1.5	1, 4
		Mid-Rise Annunciation Identification	Sec. 320.1.6	Sec. 321.1.6	3, 4
		Mid-Rise Elevators	Sec. 320.1.7	Sec. 321.1.7	4
		Mid-Rise Fire Department Communication System	Sec. 320.1.8	Sec. 321.1.8	4
		Mid-Rise Means of Egress	Sec. 320.1.9	Sec. 321.1.9	4
		Mid-Rise Extent of Enclosure	Sec. 320.1.9.1	Sec. 321.1.9.1	4
		Mid-Rise Pressurized Enclosures and Stairways	Sec. 320.1.9.2	Sec. 321.1.9.2	4
		Mid-Rise Vestibules	Sec. 320.1.9.3	Sec. 321.1.9.3	4
		Mid-Rise Pressure Differences	Sec. 320.1.9.4	Sec. 321.1.9.4	4
		Mid-Rise Locking of Stairway Doors	Sec. 320.1.9.5	Sec. 321.1.9.6	4
Sec. 96.1.321	Sec. 96.1.322	Storage of Firewood	Sec. 321	Sec. 322	4
Sec. 96.1.501.3.1	Sec. 96.1.501.3.1	Fire Apparatus Access Modifications	Sec. 501.3.1	Sec. 501.3.1	NC
Sec. 96.1.503	Sec. 96.1.503	Fire Apparatus Access Roads	Sec. 503	Sec. 503	NC
		Fire Apparatus Access Roads General	Sec. 503.1	Sec. 503.1	1, 3
		Fire Apparatus Access Roads Buildings and Facilities	Sec. 503.1.1	Sec. 503.1.1	1, 2, 3, 4
		Fire Apparatus Access Roads Additional Access	Sec. 503.1.2	Sec. 503.1.2	1, 2, 3, 4
		Fire Apparatus Access Roads Dead Ends	Sec. 503.1.3	Sec. 503.2.5.1	1,2,3,4

County Section Old	County Section New	Subject	Fire District Section Old	Fire District Section New	Difference
		Fire Apparatus Access Roads High Piled Storage	Sec. 503.1.4	Sec. 503.1.3	4
		Fire Apparatus Access Roads Specifications	Sec. 503.2	Sec. 503.2	1, 4
		Fire Apparatus Access Roads Dimensions	Sec. 503.2.1	Sec. 503.2.1	1, 2, 3, 4
		Fire Apparatus Access Roads Authority to Increase Minimum	Sec. 503.2.2	Sec. 503.2.2	NC
		Fire Apparatus Access Roads Surface	Sec. 503.2.3	Sec. 503.2.3	1
		Fire Apparatus Access Roads Roadway Radius	Sec. 503.2.4	Sec. 503.2.4	1
		Fire Apparatus Access Roads Dead End Roads	Sec. 503.2.5	Sec. 503.2.5	1
		Fire Apparatus Access Roads Bridges and Elevated Surfaces	Sec. 503.2.6	Sec. 503.2.6	1
		Fire Apparatus Access Roads Bridges with 1 traffic lane	Sec. 503.2.6	Sec. 503.2.6.1	1
		Fire Apparatus Access Roads Grade	Sec. 503.2.7	Sec. 503.2.7	1
		Fire Apparatus Access Roads Cross Slope		Sec. 503.2.7.1	1, 4
		Fire Apparatus Access Roads Angles of Approach		Sec. 503.2.8	1, 4
		Fire Apparatus Access Roads Roadway Turn Outs	Sec. 503.2.9	Sec. 503.2.9	1, 4
		Fire Apparatus Access Roads Marking	Sec. 503.3	Sec. 503.3	1, 4
		Fire Apparatus Access Roads Fire Lane Designation	Sec. 503.3.1	Sec. 503.3.1	1, 4
		Fire Apparatus Access Roads Obstruction of Fire Apparatus Roads	Sec. 503.4	Sec. 503.4	1, 4
		Fire Apparatus Access Roads Traffic Calming Devices	Sec. 503.4.1	Sec. 503.4.1	1, 4
		Fire Apparatus Access Roads Required Gates or Barricades	Sec. 503.5	Sec. 503.5	NC
		Fire Apparatus Access Roads Secured Gates and Barricades	Sec. 503.5.1	Sec. 503.5.1	1, 4
		Fire Apparatus Access Roads School Fences and Gates	Sec. 503.5.2	Sec. 503.5.2	1



County Section Old	County Section New	Subject	Fire District Section Old	Fire District Section New	Difference
		Fire Apparatus Access Roads Security Gates	Sec. 503.6	Sec. 503.6	1
Sec. 96.1.505	Sec. 96.1.505	Premises Identification	Sec. 505.1	Sec. 505.1	1
		Street or Road Signs	Sec. 505.2	Sec. 505.2	NC
		Traffic Access Limitations	Sec. 505.2.1	Sec. 505.2.1	1
		Easement Address Signs	Sec. 505.3	Sec. 505.3	1
		Directory Map	Sec. 505.4	Sec. 505.4	1
		Response Map Updates	Sec. 505.5	Sec. 505.5	1
Sec. 96.1.506.1.3	Sec. 96.1.506.1.3	Emergency Key Access	Sec. 506.1.3	Sec. 506.1.3	1, 3
Sec. 96.1.507.2	Sec. 96.1.507.2	Type of Water Supply	Sec. 507.2	Sec. 507.2	1, 4
		Private fire service Mains	Sec. 507.2.1	Sec. 507.2.1	1, 2
		Water Storage Tanks	Sec. 507.2.2	Sec. 507.2.2	1, 2, 4
Sec. 96.1.507.3	Sec. 96.1.507.3	Fire Flow	Sec. 507.3	Sec. 507.3	1, 4
Sec. 96.1.507.5.7	Sec. 96.1.507.5.7	Fire Hydrant and Fire Valve Location	Sec. 507.5.7	Sec. 507.5.7	1, 4
		Signing of Water Sources and Fire Department Connections	Sec. 507.5.7.1	Sec. 507.5.7.1	1
Sec. 96.1.507.5.9	Sec. 96.1.507.5.7	Waterline Extensions	Sec. 507.5.9	Sec. 507.5.8	1,4
Sec. 96.1.603.6.6	Sec. 96.1.603.6.6	Spark Arresters	Sec. 603.6.6	Sec. 603.6.6	1
Sec. 96.1.603.8.1	Sec. 96.1.603.8.1	Residential Incinerators	Sec. 603.8.1	Sec. 603.8.1	1
Sec. 96.1.605.11.1.3.3		Smoke Ventilation	Sec. 605.11.1.3.3	Sec. 1204.3.3	4
Sec. 96.1.605.11.2	Sec. 96.1.1204.4	Ground Mounted Photovoltaic Arrays	Sec. 605.11.2	Sec. 1204.4	4
		Fire Apparatus Access Roads	Sec. 605.11.2.1	Sec. 1204.4.1	4
		Perimeter Fire Apparatus Access Roadway	Sec. 605.11.2.1.1	Sec. 1204.4.2	4
		Fuel Modification	Sec. 605.11.2.2	Sec. 1204.4.3	4
		Water Supply	Sec. 605.11.2.3	Sec. 1204.4.4	4
		Identification	Sec. 605.11.2.4	Sec. 1204.5	4
Sec. 96.1.901.4.7		Fire Department Connections	Sec. 901.4.7	Sec. 912	4
Sec. 96.1.901.8.3		Fire Hydrants and Fire Appliances	Sec. 901.8.3		3
Sec. 96.1.903.2	Sec. 96.1.903.2	Automatic Sprinkler Systems Where Required	Sec. 903.2	Sec. 903.2	1,2,3,4
		Additions	Sec. 903.2.1	Sec. 903.2(a)	1, 4

County Section Old	County Section New	Subject	Fire District Section Old	Fire District Section New	Difference
		Remodels or Reconstruction	Sec. 903.2.2	Sec. 903.2(b)	1, 4
		Group U Occupancies		Sec. 903.2(c)	4
Sec. 96.1.903.4	Sec. 96.1.903.4	Sprinkler System Monitoring and Alarms	Sec. 903.4	Sec. 903.4	1
Sec. 96.1.2808	Sec. 96.1.2808	Storage and Processing of Wood Chips, Hogged Materials, Fines, Compost, Solid Biomass Feedstock and Raw Product associated with Yard Waste, Agro- Industrial and Recycling Facilities	Sec. 2808	Sec. 2808	NC
Sec. 96.1.3206.2	Sec. 3206.2	General Fire Protection and Life Safety Features	Sec. 3206.2	Sec. 3206.2	NC
Sec. 96.1.3318	Sec. 96.1.3318	Fuel Modification Zone Requirements	Sec. 3318	Sec. 3318	NC
Sec. 96.1.4902	Sec. 96.1.4902	Definitions	Sec. 4902	Sec. 4902	4
		Declaration	Sec. 4902.2	Sec. 4902.2	NC
Sec. 96.1.4903	Sec. 96.1.4903	Fire Protection Plan	Sec. 4903	Sec. 4903	NC
Sec. 96.1.4905	Sec. 96.1.4905	Wildfire Protection Building Construction	Sec. 4905	Sec. 4905	NC
Sec. 96.1.4907	Sec. 96.1.4907	Defensible Space	Sec. 4907	Sec. 4907	1, 4
		Buildings and Structures setbacks from property line	Sec. 4907.1	Sec. 4907.1	4
		General Fire Setbacks	Sec. 4907.1.1	Sec. 4907.1.1	1, 4
		Fire Setbacks adjacent protected areas	Sec. 4907.1.2	Sec. 4907.1.2	1, 4
		Buildings and Structure Setback from Slope	Sec. 4907.1.3	Sec. 4907.1.3	4
		Fuel Modification	Sec. 4907.2	Sec. 4907.2	4
		Fuel Modification of Combustible Vegetation from Sides of Roadways	Sec. 4907.2.1	Sec. 4907.2.1	4
		Community Fuel Modification	Sec. 4907.2.2	Sec. 4907.2.2	NC
		Land ownership	Sec. 4907.2.2.1	Sec. 4907.2.2.1	NC
		Maintenance of Defensible Space	Sec. 4907.3	Sec. 4907.3	NC
		Trees	Sec. 4907.3.1	Sec. 4907.3.1	NC
		Orchards, Groves and Vineyards	Sec. 4907.3.2	Sec. 4907.3.2	NC
		Home Ignition Zones		Sec. 4907.4	4
		Zone 1 Immediate Zone 0-5' from furthest projection		Sec. 4907.4.1	4

County Section Old	County Section New	Subject	Fire District Section Old	Fire District Section New	Difference
		Zone 2 Intermediate Zone 5'-50' from zone 1		Sec. 4907.4.2	4
		Zone 3 Extended Zone 50'-100' from zone 2		Sec. 4907.4.3	4
		Landscape Plans	Sec. 4907.4	Sec. 4907.5	4
Sec. 96.1.5601.2	Sec. 96.1.5601.2	Explosives and Fireworks Applicability	Sec. 5601.2	Sec. 5601.2	1
Sec. 96.1.5608.1	Sec. 96.1.5608.1	Fireworks Display	Sec. 5608.1	Sec. 5608.1	1
Sec. 96.1.5705.2.4	Sec. 96.1.5705.2.4	Transferring Class I, II or III Liquids	Sec. 5705.2.4	Sec. 5705.2.4	1
Sec. 96.1.5706.2.5.2.1	Sec. 5706.2.5.2.1	Tanks for Gravity Discharge	Sec. 5706.2.5.2.1	Sec. 5706.2.5.2.1	NC
Sec. 96.1.5706.2.8.2	Sec. 5706.2.8.2	Prohibition on Use of Tank Vehicle	Sec. 5706.2.8.2	Sec. 5706.2.8.2	NC
Sec. 96.1.6107.5	Sec. 6107.5	Safety Precautions and Devices Securing LPG	Sec. 6107.5	Sec. 6107.5	1
Sec. 96.1.8001	Sec. 96.1.8001	Referenced Standards	Sec. 8001	Sec. 8001	1, 2, 3, 4
		NFPA 13D	Sec. 8001	Sec. 8001	1, 2, 3, 4
		Spare Sprinkler Heads	5.1.1.2	5.1.1.2	NC
		Pressure Reducing Valve	7.1.5	7.1.5	1, 3, 4
		Pressure Gauge	7.3.3	7.3.4	1, 4
		Alarms	7.6	7.6	1, 4
		Sprinklered areas to be omitted	8.3.2	8.3.2	NC
		Installing sprinklers in garages	8.3.4	8.3.4	NC
		Installing sprinkler above FAU	8.5.1.1	8.3.5.1.1	NC
		3-Head Calculation	10.2.4.1	10.2.4.1	NC
		Pressure cushion	10.2.5	10.2.5	NC
		Hydrostatic Test	11.2.1.1	11.2.1.1	NC
		Inactive Systems	12.3.3	12.3.6	4
Sec. 96.1.APP.B103.3	Sec. 96.1.APP.B103.	Areas Without Water Supply Systems	Appendix B103.3	Appendix B103.3	NC
Sec. 96.1.APP.H100	Sec.96.1.APP.H100	Reporting Forms	Appendix H	Appendix H	NC
Sec. 96.1.007	Sec. 96.1.007	Effective Date			

### INDEX BY SUBJECT CONSOLIDATED FIRE CODE

Differences:

1. Showed the language and text that is different from the California Fire Code and the County Code as shown in Italics.
2. Changed punctuation or a grammatical change.
3. Words were deleted or sections deleted. County amendments were not necessary as section was adopted in model code language.
4. Revised or amended texts. Changes from the previous code that have been revised.
5. NC means no changes made. Language is the same.

Subject	County Section Old	County Section New	Fire District Section Old	Fire District Section New	Difference
3-Head Calculation			10.2.4.1	10.2.4.1	NC
Additions			Sec. 903.2.1	Sec. 903.2(a)	1, 4
Adoption of County Amendments to the CFC	Sec. 96.1.001	Sec 96.1.001	Section 2	Section 2	4
Alarms			7.6	7.6	1, 4
Appeals	Sec. 96.1.108	Sec. 96.1.109	Sec. 108	Sec. 109	1, 4
Application of the CCC	Sec. 1.001	Sec 1.001			4
Areas Without Water Supply Systems	Sec. 96.1.APP.B103.3	Sec. 96.1.APP.B103.	Appendix B103.3	Appendix B103.3	NC
Attendance of Open Burning and Recreational Fires	Sec. 96.1.307.5	Sec. 96.1.307.5	Sec. 307.5	Sec. 307.5	1,4
Automatic Sprinkler Systems Where Required	Sec. 96.1.903.2	Sec. 96.1.903.2	Sec. 903.2	Sec. 903.2	1,2,3,4
Buildings and Structure Setback from Slope			Sec. 4907.1.3	Sec. 4907.1.3	4
Buildings and Structures setbacks from property line			Sec. 4907.1	Sec. 4907.1	4
Christmas Tree Lots	Sec. 96.1.105.6.6.1	Sec. 96.1.105.6.6.52	Sec. 105.6.6.1	Sec. 105.6.6.52	4
Community Fuel Modification			Sec. 4907.2.2	Sec. 4907.2.2	NC
Cost Recovery	Sec. 96.1.104.12	Sec. 96.1.104.12	Sec. 104.12	Sec. 104.12	NC
Declaration			Sec. 4902.2	Sec. 4902.2	NC
Defensible Space	Sec. 96.1.4907	Sec. 96.1.4907	Sec. 4907	Sec. 4907	1, 4
Definitions	Sec. 96.1.202	Sec. 96.1.202	Sec. 202	Sec. 202	1,2,4
Definitions	Sec. 96.1.4902	Sec. 96.1.4902	Sec. 4902	Sec. 4902	4
Deletions, Revisions, Additions and Numerical	Sec. 96.1.006	Sec. 96.1.006			4
Directory Map			Sec. 505.4	Sec. 505.4	1
Easement Address Signs			Sec. 505.3	Sec. 505.3	1
Effective Date	Sec. 96.1.007	Sec. 96.1.007			

Subject	County Section Old	County Section New	Fire District Section Old	Fire District Section New	Difference
Emergency Key Access	Sec. 96.1.506.1.3	Sec. 96.1.506.1.3	Sec. 506.1.3	Sec. 506.1.3	1, 3
Expense Recovery	Sec. 96.1.105.3.9	Sec. 96.1.105.3.9	Sec. 105.3.9	Sec. 105.3.9	NC
Explanation of CFC to 2019 Fire Code	Sec. 96.1.002	Sec. 96.1.002			4
Explanation of County Fire Code adding 96.1	Sec. 96.1.003	Sec. 96.1.003			4
Explanation of the CCC	Sec. 1.002	Sec 1.002			4
Explosives and Fireworks Applicability	Sec. 96.1.5601.2	Sec. 96.1.5601.2	Sec. 5601.2	Sec. 5601.2	1
Failure to Comply			Sec. 111.4	Sec. 112.4	4
Fire Apparatus Access Modifications	Sec. 96.1.501.3.1	Sec. 96.1.501.3.1	Sec. 501.3.1	Sec. 501.3.1	NC
Fire Apparatus Access Roads	Sec. 96.1.503	Sec. 96.1.503	Sec. 503	Sec. 503	NC
Fire Apparatus Access Roads			Sec. 605.11.2.1	Sec. 1204.4.1	4
Fire Apparatus Access Roads Additional Access			Sec. 503.1.2	Sec. 503.1.2	1, 2, 3, 4
Fire Apparatus Access Roads Angles of Approach				Sec. 503.2.8	1, 4
Fire Apparatus Access Roads Authority to Increase Minimum			Sec. 503.2.2	Sec. 503.2.2	NC
Fire Apparatus Access Roads Bridges and Elevated Surfaces			Sec. 503.2.6	Sec. 503.2.6	1
Fire Apparatus Access Roads Bridges with 1 traffic lane			Sec. 503.2.6	Sec. 503.2.6.1	1
Fire Apparatus Access Roads Buildings and Facilities			Sec. 503.1.1	Sec. 503.1.1	1, 2, 3, 4
Fire Apparatus Access Roads Cross Slope				Sec. 503.2.7.1	1, 4
Fire Apparatus Access Roads Dead End Roads			Sec. 503.2.5	Sec. 503.2.5	1
Fire Apparatus Access Roads Dead Ends			Sec. 503.1.3	Sec. 503.2.5.1	1,2,3,4

Subject	County Section Old	County Section New	Fire District Section Old	Fire District Section New	Difference
Fire Apparatus Access Roads Dimensions			Sec. 503.2.1	Sec. 503.2.1	1, 2, 3, 4
Fire Apparatus Access Roads Fire Lane Designation			Sec. 503.3.1	Sec. 503.3.1	1, 4
Fire Apparatus Access Roads General			Sec. 503.1	Sec. 503.1	1, 3
Fire Apparatus Access Roads Grade			Sec. 503.2.7	Sec. 503.2.7	1
Fire Apparatus Access Roads High Piled Storage			Sec. 503.1.4	Sec. 503.1.3	4
Fire Apparatus Access Roads Marking			Sec. 503.3	Sec. 503.3	1, 4
Fire Apparatus Access Roads Obstruction of Fire Apparatus Roads			Sec. 503.4	Sec. 503.4	1, 4
Fire Apparatus Access Roads Required Gates or Barricades			Sec. 503.5	Sec. 503.5	NC
Fire Apparatus Access Roads Roadway Radius			Sec. 503.2.4	Sec. 503.2.4	1
Fire Apparatus Access Roads Roadway Turn Outs			Sec. 503.2.9	Sec. 503.2.9	1, 4
Fire Apparatus Access Roads School Fences and Gates			Sec. 503.5.2	Sec. 503.5.2	1
Fire Apparatus Access Roads Secured Gates and Barricades			Sec. 503.5.1	Sec. 503.5.1	1, 4
Fire Apparatus Access Roads Security Gates			Sec. 503.6	Sec. 503.6	1
Fire Apparatus Access Roads Specifications			Sec. 503.2	Sec. 503.2	1, 4
Fire Apparatus Access Roads Surface			Sec. 503.2.3	Sec. 503.2.3	1
Fire Apparatus Access Roads Traffic Calming Devices			Sec. 503.4.1	Sec. 503.4.1	1, 4
Fire Department Connections	Sec. 96.1.901.4.7		Sec. 901.4.7	Sec. 912	4
Fire Flow	Sec. 96.1.507.3	Sec. 96.1.507.3	Sec. 507.3	Sec. 507.3	1, 4

Subject	County Section Old	County Section New	Fire District Section Old	Fire District Section New	Difference
Fire Hydrant and Fire Valve Location	Sec. 96.1.507.5.7	Sec. 96.1.507.5.7	Sec. 507.5.7	Sec. 507.5.7	1, 4
Fire Hydrants and Fire Appliances	Sec. 96.1.901.8.3		Sec. 901.8.3		3
Fire Protection Plan	Sec. 96.1.4903	Sec. 96.1.4903	Sec. 4903	Sec. 4903	NC
Fire Setbacks adjacent protected areas			Sec. 4907.1.2	Sec. 4907.1.2	1, 4
Fireworks Display	Sec. 96.1.5608.1	Sec. 96.1.5608.1	Sec. 5608.1	Sec. 5608.1	1
Fuel Modification			Sec. 605.11.2.2	Sec. 1204.4.3	4
Fuel Modification			Sec. 4907.2	Sec. 4907.2	4
Fuel Modification of Combustible Vegetation from Sides of Roadways			Sec. 4907.2.1	Sec. 4907.2.1	4
Fuel Modification Zone Requirements	Sec. 96.1.3318	Sec. 96.1.3318	Sec. 3318	Sec. 3318	NC
General Fire Protection and Life Safety Features	Sec. 96.1.3206.2	Sec. 3206.2	Sec. 3206.2	Sec. 3206.2	NC
General Fire Setbacks			Sec. 4907.1.1	Sec. 4907.1.1	1, 4
Geographic Limits	Sec. 96.1.005	Sec. 96.1.005			NC
Greenwaste Recycling, Mulching, Composting & Storage	Sec. 96.1.105.6.20.1	Sec. 96.1.105.6.20.1	Sec. 105.6.20.1	Sec. 105.6.20.1	NC
Ground Mounted Photovoltaic Arrays	Sec. 96.1.605.11.2	Sec. 96.1.1204.4	Sec. 605.11.2	Sec. 1204.4	4
Group U Occupancies				Sec. 903.2(c)	4
Home Ignition Zones				Sec. 4907.5	4
Hydrostatic Test			11.2.1.1	11.2.1.1	NC
Identification			Sec. 605.11.2.4	Sec. 1204.5	4
Inactive Systems			12.3.3	12.3.6	4
Installing sprinkler above FAU			8.5.1.1	8.3.5.1.1	NC
Installing sprinklers in garages			8.3.4	8.3.4	NC
Land ownership			Sec. 4907.2.2.1	Sec. 4907.2.2.1	NC
Maintenance of Defensible Space			Sec. 4907.3	Sec. 4907.3	NC
Mid-Rise Annunciation Identification			Sec. 320.1.6	Sec. 321.1.6	3, 4
Mid-Rise Automatic Sprinkler System & Standpipes			Sec. 320.1.1	Sec. 321.1.1	4
Mid-Rise Buildings	Sec. 96.1.320	Sec. 96.1.321	Sec. 320	Sec. 321	1, 4
Mid-Rise Elevators			Sec. 320.1.7	Sec. 321.1.7	4
Mid-Rise Emergency Voice Alarm Signaling System			Sec. 320.1.4	Sec. 321.1.4	4

Subject	County Section Old	County Section New	Fire District Section Old	Fire District Section New	Difference
Mid-Rise Extent of Enclosure			Sec. 320.1.9.1	Sec. 321.1.9.1	4
Mid-Rise Fire Alarm			Sec. 320.1.3	Sec. 321.1.4	4
Mid-Rise Fire Command Center			Sec. 320.1.5	Sec. 321.1.5	1, 4
Mid-Rise Fire Department Communication System			Sec. 320.1.8	Sec. 321.1.8	4
Mid-Rise General			Sec. 320.1	Sec. 320.1	NC
Mid-Rise Locking of Stairway Doors			Sec. 320.1.9.5	Sec. 321.1.9.6	4
Mid-Rise Means of Egress			Sec. 320.1.9	Sec. 321.1.9	4
Mid-Rise Pressure Differences			Sec. 320.1.9.4	Sec. 321.1.9.4	4
Mid-Rise Pressurized Enclosures and Stairways			Sec. 320.1.9.2	Sec. 321.1.9.2	4
Mid-Rise Smoke Detection			Sec. 320.1.2	Sec. 321.1.2	4
Mid-Rise Vestibules			Sec. 320.1.9.3	Sec. 321.1.9.3	4
Modifications	Sec. 96.1.104.8	Sec. 96.1.104.8	Sec. 104.8	Sec. 104.8	1
New materials, process or Occupancies Require Permits	Sec. 96.1.105.8	Sec. 96.1.105.8	Sec. 105.8	Sec. 105.8	NC
NFPA 13D			Sec. 8001	Sec. 8001	1, 2, 3, 4
Orchards, Groves and Vineyards			Sec. 4907.3.2	Sec. 4907.3.2	NC
Outdoor Carnivals and Fairs	Sec. 96.1.304.1.4	Sec. 96.1.304.1.4	Sec. 304.1.4	Sec. 304.1.4	NC
Perimeter Fire Apparatus Access Roadway			Sec. 605.11.2.1.1	Sec. 1204.4.2	4
Premises Identification	Sec. 96.1.505	Sec. 96.1.505	Sec. 505.1	Sec. 505.1	1
Pressure cushion			10.2.5	10.2.5	NC
Pressure Gauge			7.3.3	7.3.4	1, 4
Pressure Reducing Valve			7.1.5	7.1.5	1, 3, 4
Private fire service Mains			Sec. 507.2.1	Sec. 507.2.1	1, 2
Prohibition on Use of Tank Vehicle	Sec. 96.1.5706.2.8.2	Sec. 5706.2.8.2	Sec. 5706.2.8.2	Sec. 5706.2.8.2	NC
Referenced Standards	Sec. 96.1.8001	Sec. 96.1.8001	Sec. 8001	Sec. 8001	1, 2, 3, 4
Remodels or Reconstruction			Sec. 903.2.2	Sec. 903.2(b)	1, 4
Repeal of Conflicting Ordinances, Resolutions or Motions	Sec. 96.1.102.13	Sec. 96.1.102.13	Sec. 102.13	Sec. 102.13	NC



Subject	County Section Old	County Section New	Fire District Section Old	Fire District Section New	Difference
Reporting Forms	Sec. 96.1.APP.H100	Sec.96.1.APP.H100	Appendix H	Appendix H	NC
Residential Incinerators	Sec. 96.1.603.8.1	Sec. 96.1.603.8.1	Sec. 603.8.1	Sec. 603.8.1	1
Response Map Updates			Sec. 505.5	Sec. 505.5	1
Responsibility for Enforcement	Sec. 96.1.004	Sec 96.1.004			NC
Safety Precautions and Devices Securing LPG	Sec. 96.1.6107.5	Sec. 6107.5	Sec. 6107.5	Sec. 6107.5	1
Signing of Water Sources and Fire Department Connections			Sec. 507.5.7.1	Sec. 507.5.7.1	1
Smoke Ventilation	Sec. 96.1.605.11.1.3.3		Sec. 605.11.1.3.3	Sec. 1204.3.3	4
Spare Sprinkler Heads			5.1.1.2	5.1.1.2	NC
Spark Arresters	Sec. 96.1.603.6.6	Sec. 96.1.603.6.6	Sec. 603.6.6	Sec. 603.6.6	1
Sprinkler System Monitoring and Alarms	Sec. 96.1.903.4	Sec. 96.1.903.4	Sec. 903.4	Sec. 903.4	1
Sprinklered areas to be omitted			8.3.2	8.3.2	NC
Storage and Processing of Wood Chips, Hogged Materials, Fines, Compost, Solid Biomass Feedstock and Raw Product associated with Yard Waste, Agro-Industrial and Recycling Facilities	Sec. 96.1.2808	Sec. 96.1.2808	Sec. 2808	Sec. 2808	NC
Storage of Firewood	Sec. 96.1.321	Sec. 96.1.322	Sec. 321	Sec. 322	4
Street or Road Signs			Sec. 505.2	Sec. 505.2	NC
Structure Setback from Slope			Sec. 4907.1.3	Sec. 4907.1.3	NC
Structures setbacks from property line			Sec. 4907.1	Sec. 4907.1	NC
Tanks for Gravity Discharge	Sec. 96.1.5706.2.5.2.1	Sec. 5706.2.5.2.1	Sec. 5706.2.5.2.1	Sec. 5706.2.5.2.1	NC
Traffic Access Limitations			Sec. 505.2.1	Sec. 505.2.1	1
Transferring Class I, II or III Liquids	Sec. 96.1.5705.2.4	Sec. 96.1.5705.2.4	Sec. 5705.2.4	Sec. 5705.2.4	1
Trees			Sec. 4907.3.1	Sec. 4907.3.1	NC
Type of Water Supply	Sec. 96.1.507.2	Sec. 96.1.507.2	Sec. 507.2	Sec. 507.2	1, 4
Validity	Sec. 96.1.105.5	Sec. 96.1.105.5	Sec. 101.5	Sec. 101.5	1
Violations, Penalties and Responsibilities for Compliance	Sec. 96.1.109.4	Sec. 96.1.110.4	Sec. 109.4	Sec. 110.4	1, 4

<b>Subject</b>	<b>County Section Old</b>	<b>County Section New</b>	<b>Fire District Section Old</b>	<b>Fire District Section New</b>	<b>Difference</b>
Water Storage Tanks			Sec. 507.2.2	Sec. 507.2.2	1, 2, 4
Water Supply			Sec. 605.11.2.3	Sec. 1204.4.4	4
Waterline Extensions	Sec. 96.1.507.5.9	Sec. 96.1.507.5.7	Sec. 507.5.9	Sec. 507.5.8	1,4
Wildfire Protection Building Construction	Sec. 96.1.4905	Sec. 96.1.4905	Sec. 4905	Sec. 4905	NC
Zone 1 Immediate Zone 0-5' from furthest projection				Sec. 4907.5.1	4
Zone 2 Intermediate Zone 5'-50' from zone 1				Sec. 4907.5.2	4
Zone 3 Extended Zone 50'-100' from zone 2				Sec. 4907.5.3	4

# Residential Emergency Vehicle Turnaround

## Hammerhead Turnaround

Residential fire access road/driveway serving no more than two dwellings...

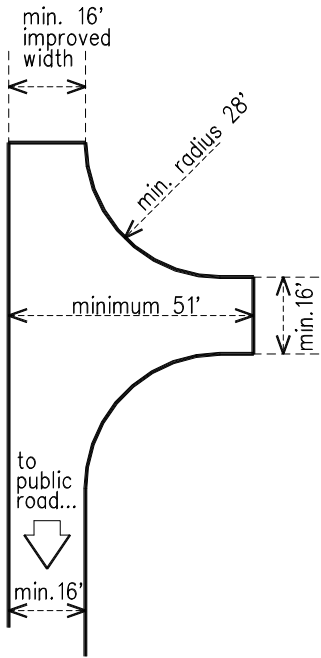

Option #1

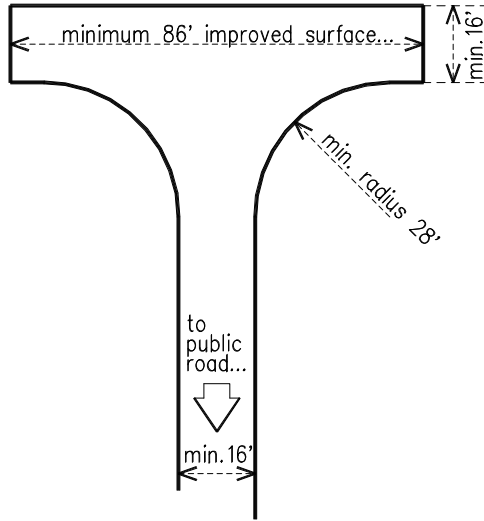

Option #2

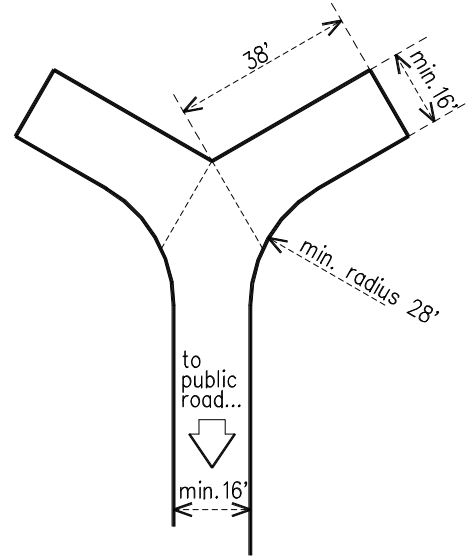

Option #3

## Cul-de-sac Turnaround

Residential fire access road serving three or more dwellings...

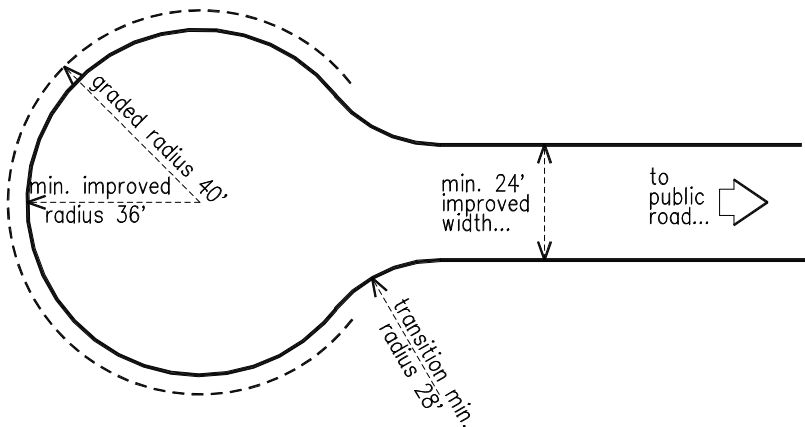

## Approved Residential Turn-Out

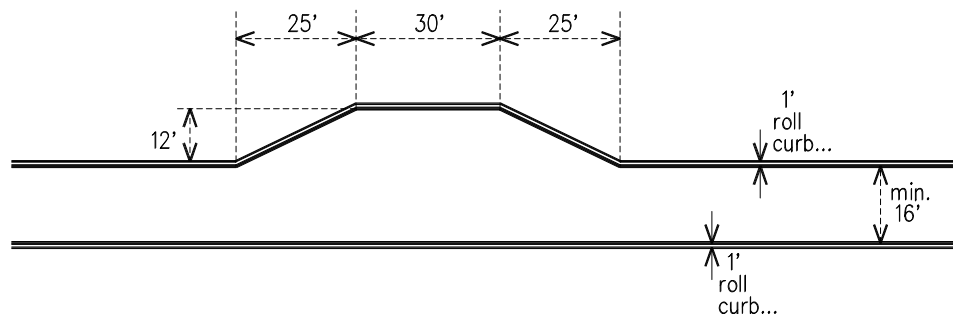

# Residential Emergency Vehicle Turnaround

## Hammerhead Turnaround

Residential fire access road/driveway serving no more than two dwellings...

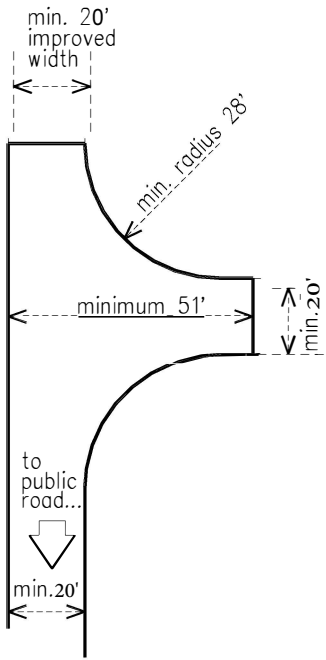

Option #1

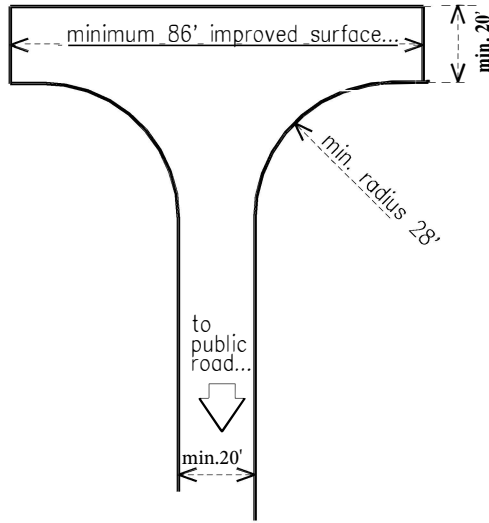

Option #2

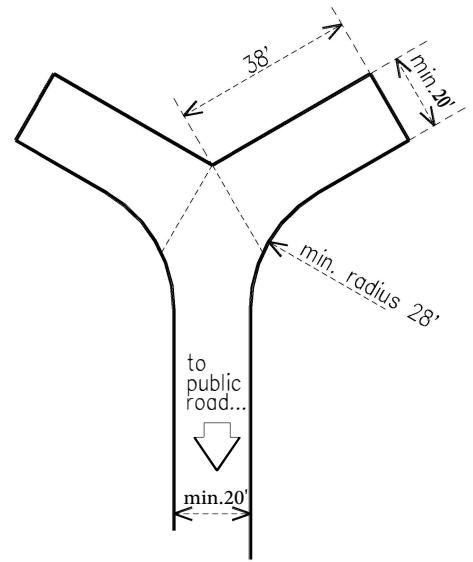

Option #3

## Cul-de-sac Turnaround

Residential fire access road serving three or more dwellings...

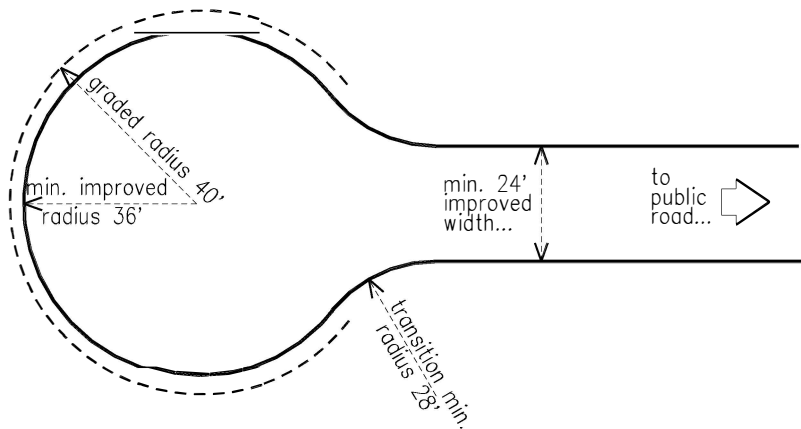

## Approved Residential Turn-Out

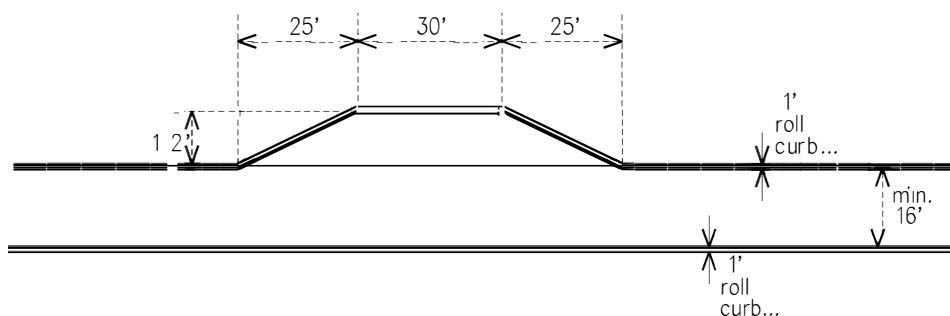

# Emergency Vehicle Turnaround

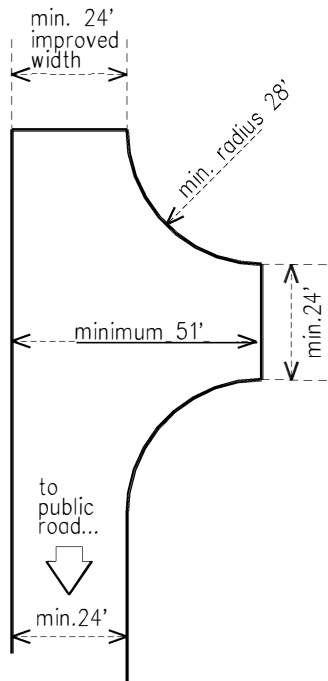

Option #1

## Hammerhead Turnaround

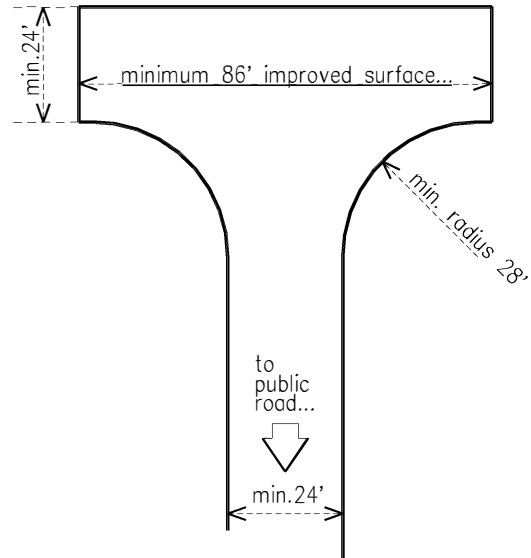

Option #2

## Cul-de-sac Turnaround

Commercial fire apparatus access roadway...

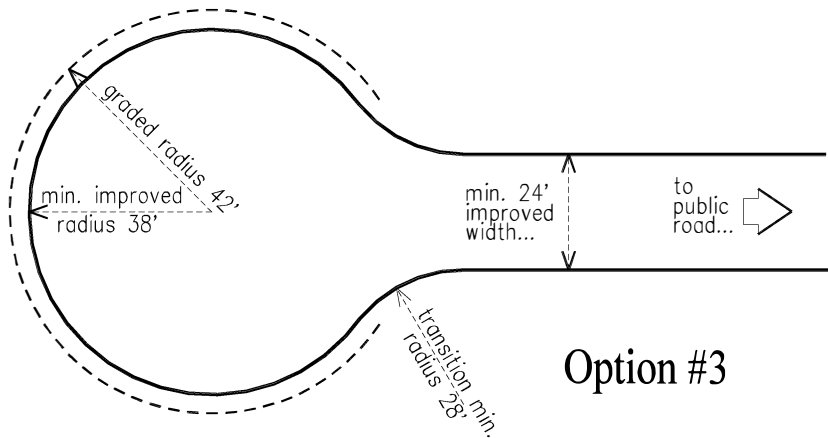

Option #3